

Industrial Automation Headquarters

Delta Electronics, Inc.
Taoyuan Technology Center
No.18, Xinglong Rd., Taoyuan District,
Taoyuan City 33068, Taiwan
TEL: 886-3-362-6301 / FAX: 886-3-371-6301

Asia

Delta Electronics (Shanghai) Co., Ltd.
No.182 Minyu Rd., Pudong Shanghai, P.R.C.
Post code : 201209
TEL: 86-21-6872-3988 / FAX: 86-21-6872-3996
Customer Service: 400-820-9595

Delta Electronics (Japan), Inc.
Tokyo Office
Industrial Automation Sales Department
2-1-14 Shibadaimon, Minato-ku
Tokyo, Japan 105-0012
TEL: 81-3-5733-1155 / FAX: 81-3-5733-1255

Delta Electronics (Korea), Inc.
Seoul Office
1511, 219, Gasan Digital 1-Ro., Geumcheon-gu,
Seoul, 08501 South Korea
TEL: 82-2-515-5305 / FAX: 82-2-515-5302

Delta Energy Systems (Singapore) Pte Ltd.
4 Kaki Bukit Avenue 1, #05-04, Singapore 417939
TEL: 65-6747-5155 / FAX: 65-6744-9228

Delta Electronics (India) Pvt. Ltd.
Plot No.43, Sector 35, HSIIDC Gurgaon,
PIN 122001, Haryana, India
TEL: 91-124-4874900 / FAX : 91-124-4874945

Delta Electronics (Thailand) PCL.
909 Soi 9, Moo 4, Bangpoo Industrial Estate (E.P.Z),
Pattana 1 Rd., T.Phraksa, A.Muang,
Samutprakarn 10280, Thailand
TEL: 66-2709-2800 / FAX : 662-709-2827

Delta Electronics (Australia) Pty Ltd.
Unit 20-21/45 Normanby Rd., Notting Hill Vic 3168, Australia
TEL: 61-3-9543-3720

Americas

Delta Electronics (Americas) Ltd.
Raleigh Office
P.O. Box 12173, 5101 Davis Drive,
Research Triangle Park, NC 27709, U.S.A.
TEL: 1-919-767-3813 / FAX: 1-919-767-3969

Delta Greentech (Brasil) S/A
São Paulo Office
Rua Itapeva, 26 – 3º Andar - Bela Vista
CEP: 01332-000 – São Paulo – SP - Brasil
TEL: 55-11-3530-8643 / 55-11-3530-8640

Delta Electronics International Mexico S.A. de C.V.
Mexico Office
Gustavo Baz No. 309 Edificio E PB 103
Colonia La Loma, CP 54060
Tlalnepantla, Estado de México
TEL: 52-55-3603-9200

DELTA_IA-MDS_VFD-EL-W_UM_EN_20200729

*We reserve the right to change the information in this catalogue without prior notice.

EMEA

Headquarters: Delta Electronics (Netherlands) B.V.
Sales: Sales.IA.EMEA@deltaww.com
Marketing: Marketing.IA.EMEA@deltaww.com
Technical Support: iatechnicalsupport@deltaww.com
Customer Support: Customer-Support@deltaww.com
Service: Service.IA.emea@deltaww.com
TEL: +31(0)40 800 3900

BENELUX: Delta Electronics (Netherlands) B.V.
De Witbogt 20, 5652 AG Eindhoven, The Netherlands
Mail: Sales.IA.Benelux@deltaww.com
TEL: +31(0)40 800 3900

DACH: Delta Electronics (Netherlands) B.V.
Coesterweg 45, D-59494 Soest, Germany
Mail: Sales.IA.DACH@deltaww.com
TEL: +49(0)2921 987 0

France: Delta Electronics (France) S.A.
ZI du bois Challand 2, 15 rue des Pyrénées,
Lisses, 91090 Evry Cedex, France
Mail: Sales.IA.FR@deltaww.com
TEL: +33(0)1 69 77 82 60

Iberia: Delta Electronics Solutions (Spain) S.L.U
Ctra. De Villaverde a Vallecas, 265 1º Dcha Ed.
Hormigueras – P.I. de Vallecas 28031 Madrid
TEL: +34(0)91 223 74 20

Carrer Llacuna 166, 08018 Barcelona, Spain
Mail: Sales.IA.Iberia@deltaww.com

Italy: Delta Electronics (Italy) S.r.l.
Via Meda 2-22060 Novedrate(CO)
Piazza Grazioli 18 00186 Roma Italy
Mail: Sales.IA.Italy@deltaww.com
TEL: +39 039 8900365

Russia: Delta Energy System LLC
Vereyskaya Plaza II, office 112 Vereyskaya str.
17 121357 Moscow Russia
Mail: Sales.IA.RU@deltaww.com
TEL: +7 495 644 3240

Turkey: Delta Greentech Elektronik San. Ltd. Sti. (Turkey)
Şerifali Mah. Hendem Cad. Kule Sok. No:16-A
34775 Ümraniye – İstanbul
Mail: Sales.IA.Turkey@deltaww.com
TEL: + 90 216 499 9910

GCC: Delta Energy Systems AG (Dubai BR)
P.O. Box 185668, Gate 7, 3rd Floor, Hamarain Centre
Dubai, United Arab Emirates
Mail: Sales.IA.MEA@deltaww.com
TEL: +971(0)4 2690148

Egypt + North Africa: Delta Electronics
Unit 318, 3rd Floor, Trivium Business Complex, North 90 street,
New Cairo, Cairo, Egypt
Mail: Sales.IA.MEA@deltaww.com



Delta Sensorless Vector Control Compact Drive VFD-EL-W Series User Manual



Copyright notice

©Delta Electronics, Inc. All rights reserved.

All information contained in this user manual is the exclusive property of Delta Electronics Inc.

(hereinafter referred to as "Delta ") and is protected by copyright law and all other laws. Delta retains the exclusive rights of this user manual in accordance with the copyright law and all other laws. No parts in this manual may be reproduced, transmitted, transcribed, translated or used in any other ways without the prior consent of Delta.

Limitation of Liability

The contents of this user manual are only for the use of the AC motor drives manufactured by Delta. Except as defined in special mandatory laws, Delta provides this user manual "as is" and does not offer any kind of warranty through this user manual for using the product, either express or implied, including but not limited to the following: (i) this product will meet your needs or expectations; (ii) the information contained in the product is current and correct; (iii) the product does not infringe any rights of any other person. You shall bear your own risk to use this product.

In no event shall Delta, its subsidiaries, affiliates, managers, employees, agents, partners and licensors be liable for any direct, indirect, incidental, special, derivative or consequential damages (including but not limited to the damages for loss of profits, goodwill, use or other intangible losses) unless the laws contains special mandatory provisions to the contrary.

Delta reserves the right to make changes to the user manual and the products described in the user manual without prior notice and afterwards.

Thank you for choosing DELTA's sensorless vector control compact drive VFD-EL-W series. The VFD-EL-W series are manufactured with high-quality components and materials and incorporate the latest microprocessor technology available.

Use this manual for the AC Motor Drive installation, parameter setting, troubleshooting, and daily maintenance. To guarantee safe operation, read the following safety guidelines before connecting power to the AC motor drive. Keep this user manual at hand and distribute to all users for reference.

To ensure the safety of operators and equipment, only qualified personnel familiar with AC motor drive are to do installation, start-up and maintenance. Always read this manual thoroughly before using VFD-EL-W series AC Motor Drive, especially the DANGER, WARNING and CAUTION notes. Failure to comply may result in personal injury and equipment damage. If you have any questions, please contact your dealer.

PLEASE READ PRIOR TO INSTALLATION FOR SAFETY.



- Disconnect AC input power before connecting any wiring to the AC motor drive.
- Even if the power has been turned off, a charge may still remain in the DC-link capacitors with hazardous voltages before the indicator on the digital keypad is OFF. Do NOT touch the internal circuits and components.
- There are highly sensitive CMOS IC components on the motor drive's printed circuit boards. These components are especially sensitive to static electricity. Take anti-static measure before touching these components or the circuit boards.
- Never modify the internal components or wiring.
- Ground the AC motor drive by using the ground terminal. The grounding method must comply with the laws of the country where the AC motor drive is to be installed.
- Use the VFD-EL-W series to control only variable speed three-phase induction motors. The VFD-EL-W is NOT for controlling one-phase motors or for other purposes.
- Do NOT use the VFD-EL-W series for life support equipment or any life safety situation.
- To prevent personal injury, keep children and unqualified people away from the equipment.



- Never connect the AC motor drive output terminals U/T1, V/T2, and W/T3 directly to the AC mains circuit power supply.
- DO NOT use a Hi-Pot test for internal components. The semiconductors used in the AC motor drive are easily damaged by high-voltage.
- Even if the three-phase AC motor is stopped, a charge with hazardous voltages may still remain in the main circuit terminals of the AC motor drive
- Only qualified persons are allowed to install, wire and maintain the AC motor drives.
- When the AC motor drive uses the external terminal as the source of the operation command, the motor may run immediately after applying power. At this time, it is dangerous if people are at the scene.



- ☑ DO NOT install the AC motor drive in a location subject to high temperature, direct sunlight, high humidity, or splash of water droplets.
- ☑ Use the AC motor drives only within specification. Failure to comply may result in fire, explosion or electric shock.
- ☑ When the motor cable between AC motor drive and motor is too long, the insulation layer of the motor may be damaged. Use a frequency inverter-duty motor or add an AC output reactor to prevent damage to the motor. Refer to Appendix B “Reactor” for details.
- ☑ The rated voltage of power system to install motor drives is listed below. Ensure that the installation voltage is in the correct range when installing a motor drive.
 1. For 230V models, the range is between 180V~264V
 2. For 460V models, the range is between 342V~528V
- ☑ The performance of electrolytic capacitor will degrade if it is not charged for a long time. It is recommended to charge the drive which is stored in no charge condition every 2 years for 3~4 hours to restore the performance of electrolytic capacitor in the motor drive. Note: When power up the motor drive, use adjustable AC power source (ex. AC autotransformer) to charge the drive at 70%~80% of rated voltage for 30 minutes (do not run the motor drive). Then charge the drive at 100% of rated voltage for an hour (do not run the motor drive). By doing these, restore the performance of electrolytic capacitor before starting to run the motor drive. Do NOT run the motor drive at 100% rated voltage right away.
- ☑ Pay attention to the following precautions when transporting and installing this package (including wooden crate and wood stave)
 1. If you need to deworm the wooden crate, do NOT use fumigation or you will damage the drive. Any damage to the drive caused by using fumigation voids the warranty.
 2. Use other methods, such as heat treatment or any other non-fumigation treatment, to deworm the wood packaging material.
 3. If you use heat treatment to deworm, leave the packaging materials in an environment of over 56°C for a minimum of thirty minutes.
- ☑ If the motor drive generates leakage current goes over AC 3.5 mA or over DC 10 mA on a protective earth (PE) conductor, the PE conductor must be a copper wire with a cross section of minimum 10mm² or an aluminum wire with a cross section of at least 16mm². You can also install an earth-leakage circuit breaker (ELCB).

NOTE

- In order to explain the details of the product, the outer casing or the safety cover is removed and described as a figure. During operation, it is necessary to install the casing and wiring in accordance with the regulations, and operate according to the instructions to ensure safety.
- The figures shown in the manual, for the convenience of explanation, may be slightly different from the product. This is normal and does not affect your customer rights.
- The content of this manual may be revised without prior notice. Please consult our distributors or download the latest version at http://www.deltaww.com/iadownload_acmotordrive

Table of Contents

Preface	i
Table of Contents	iii
Chapter 1 Introduction	1-1
1.1 Receiving and Inspection	1-1
1.1.1 Nameplate Information	1-1
1.1.2 Model Name	1-2
1.1.3 Serial Number	1-2
1.1.4 Drive Frames and Appearances	1-3
1.2 Preparation for Installation and Wiring	1-7
1.2.1 Ambient Conditions	1-7
1.3 Dimensions	1-11
Chapter 2 Installation and Wiring	2-1
2.1 Wiring	2-2
2.2 External Wiring	2-6
2.3 Main Circuit	2-7
2.3.1 Main Circuit Connection	2-7
2.3.2 Main Circuit Terminals	2-8
2.4 Control Terminals	2-9
2.5 NPN / PNP Mode	2-12
Chapter 3 Keypad and Start Up	3-1
3.1 Description of the Digital Keypad	3-2
3.2 Operation Method	3-5
3.3 Trial Run	3-7
Chapter 4 Parameters	4-1
4.1 Summary of Parameter Settings	4-2
4.2 Parameter Settings for Applications	4-23
4.3 Description of Parameter Settings	4-27
Chapter 5 Troubleshooting	5-1
5.1 Over-Current (oc)	5-2
5.2 Over-Voltage (ov)	5-3
5.3 Low Voltage (Lv)	5-4
5.4 Overheat (oH1)	5-5
5.5 Overload (oL)	5-6
5.6 Keypad Display is Abnormal	5-7
5.7 Phase Loss (PHL)	5-7
5.8 Motor Does Not Run	5-8
5.9 Motor Speed Cannot be Changed	5-9

5.10 Motor Stalls During Acceleration	5-10
5.11 The Motor Does Not Run as Expected	5-10
5.12 Electromagnetic/Induction Noise	5-11
5.13 Operating Environment Condition	5-11
5.14 Affecting Other Machines	5-12
Chapter 6 Fault Code Information and Maintenance	6-1
6.1 Fault Code Information	6-2
6.2 Maintenance and Inspections	6-6
Appendix A Specifications	A-1
Appendix B Accessories	B-1
B.1 Non-fuse Circuit Breaker Chart	B-1
B.2 Reactor	B-2
B.2.1 AC Reactor	B-2
B.2.2 Zero Phase Reactor	B-4
B.3 Digital Keypad	B-5
B.3.1 VFD-PU06	B-5
B.3.2 VFD-PU08 and VFD-PU08V.....	B-8
B.4 Optional Fan Kit	B-10
Appendix C How to Select the Right AC Motor Drive	C-1
C.1 Capacity Formulas	C-2
C.2 General Precaution	C-4
C.3 How to Choose a Suitable Motor	C-5

Application	Firmware V2.00
	Issue Date 2020/07

This page intentionally left blank

- 1.1 Receiving and Inspection
- 1.2 Preparation for Installation and Wiring
- 1.3 Dimensions

Keep the AC motor drive in the shipping carton or crate before installation. In order to retain the warranty coverage, properly store the AC motor drive when it is not to be used for an extended period of time. The proper storage conditions are listed below.



1. Store in a clean and dry location without any direct sunlight or corrosive fumes.
2. Store in an ambient temperature range between -20°C to $+60^{\circ}\text{C}$.
3. Store in a relative humidity range between 0% to 90% and non-condensing environment.
4. DO NOT place directly on the ground. If the surrounding environment is humid, you should put a desiccant in the carton or crate.
5. DO NOT store in an area with rapid changes in temperature that may cause condensation or frost to form.
6. If the AC motor drive is stored for more than three months, the temperature should not be higher than 30°C . Storage for longer than one year is not recommended; it could result in the degradation of the electrolytic capacitors.
7. When the AC motor drive is not used for long time after installation in an environment with humidity and dust, it's best to move the AC motor drive to a better environment as stated above.

1.1 Receiving and Inspection

This VFD-EL-W AC motor drive has gone through rigorous quality control tests at the factory before shipment. After receiving the AC motor drive, please check for the following:

- Inspect the unit to ensure it was not damaged during shipment.
- Make sure that the part number indicated on the nameplate matches the part number of your order.

1.1.1 Nameplate Information

Example for 1 HP/0.75 kW three-phase 230V AC motor drive

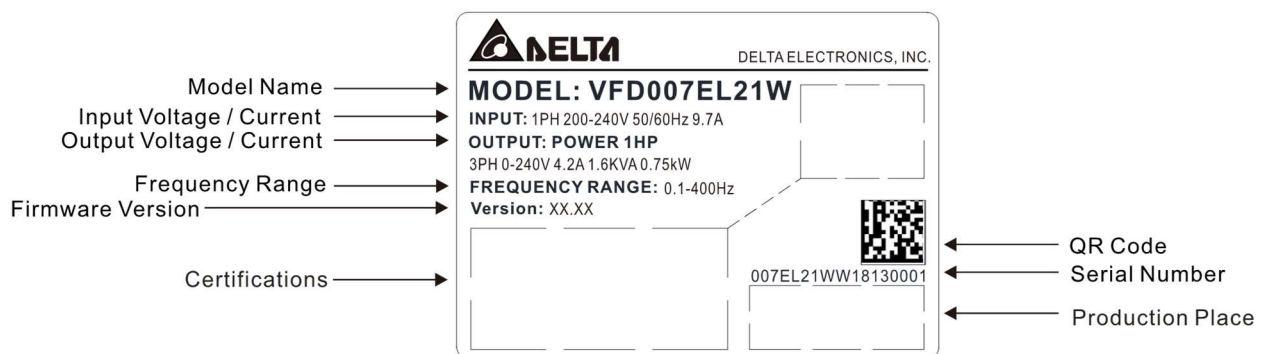

1.1.2 Model Name

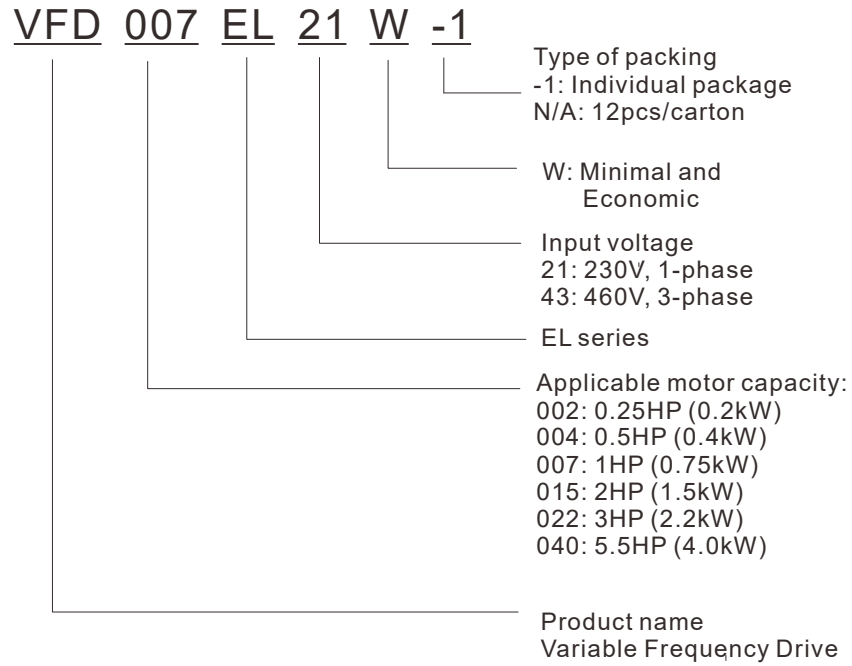

1.1.3 Serial Number

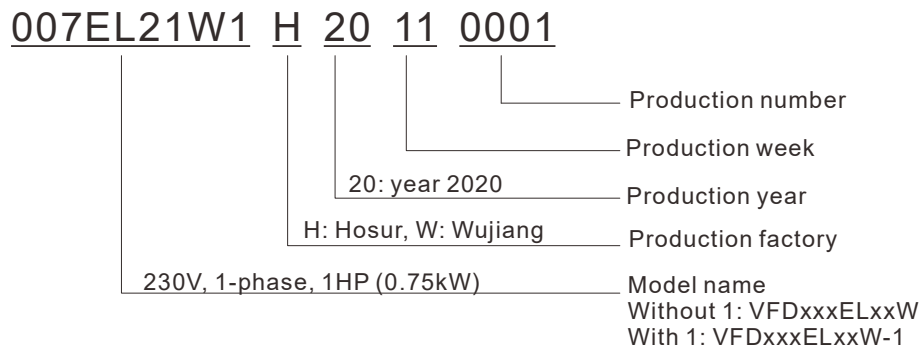

If the nameplate information does not match your purchase order or if there are any problems, please contact your distributor.

1.1.4 Drive Frames and Appearances

Frame A1

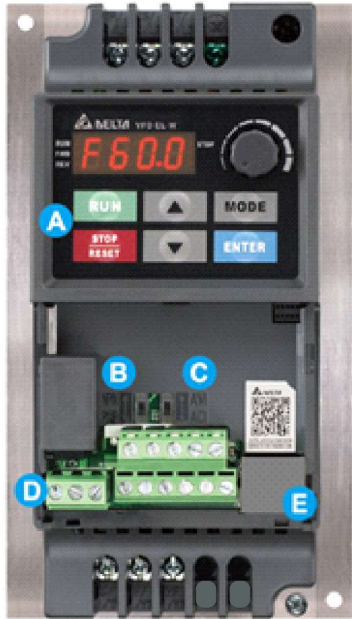

- A** digital keypad
- B** choose NPN/PNP
- C** choose ACI/AVI
- D** control terminals
- E** RS485 terminal (RJ45)

Frame A2

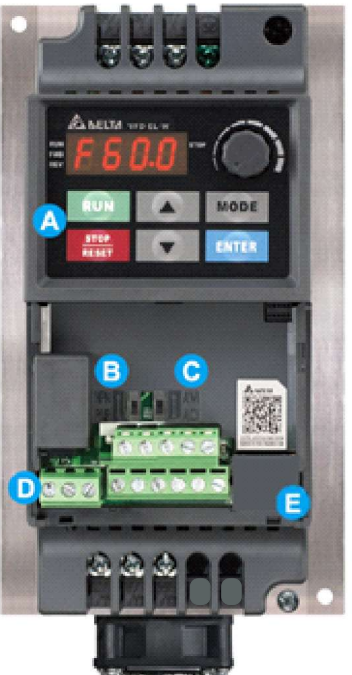

- A** digital keypad
- B** choose NPN/ PNP
- C** choose ACI/ AVI
- D** control terminals
- E** RS485 terminal (RJ45)

Frame B

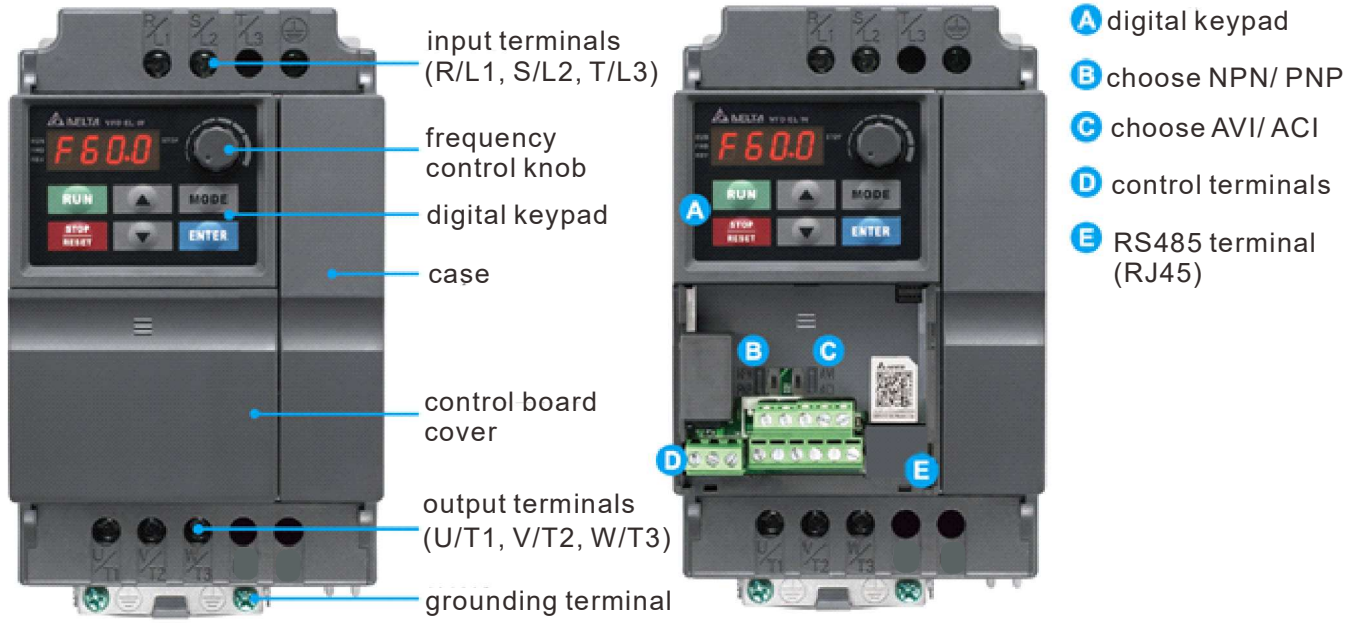

RFI Jumper Location



NOTE

If it is required by the grounding system or the current leakage is too big and causes tripping, you can remove RFI jumper which is near the input terminals (R/L1, S/L2, T/L3) by loosening screws. Once you remove the RFI jumper, retighten the screws to keep good grounding to prevent electric shock.

Frame	Power Range	Models
A1	0.25 - 1hp (0.2 - 0.75kW)	VFD002EL21W(-1), VFD004EL21W(-1) / 43W(-1), VFD007EL21W(-1) / 43W(-1),
A2	2 HP (1.5 kW)	VFD015EL43W(-1)
B	2–5.5 HP (1.5–4 kW)	VFD015EL21W(-1), VFD022EL21W / 43W(-1), VFD040EL43W(-1)

RFI Jumper

- (1) In the drive there are Varistor / MOVs, which are connected from phase to phase and from phase to ground, to protect the drive against mains surges or voltage spikes. Because the Varistors / MOVs from phase to ground are connected to ground via the RFI jumper, the protection will be ineffective when the RFI jumper is removed.
- (2) In the models with built-in EMC filter the RFI jumper connects the filter capacitors to ground to form a return path for high frequency noise to isolate the noise from contaminating the main power. Removing the RFI jumper strongly reduces the effect of the built-in EMC filter.

Isolating main power from ground:

When the power distribution system for the motor drive is a floating ground system (IT) or an asymmetric ground system (TN), you must remove the RFI jumper. Removing the RFI jumper disconnects the internal capacitors from ground to avoid damaging the internal circuits and to reduce the ground leakage current.

Important points regarding ground connection

- ☑ Do not remove RFI jumper while the power is ON.
- ☑ Make sure that main power is OFF before removing the RFI jumper.
- ☑ Removing the RFI jumper also cuts off the built-in EMC filter capacitors. Compliance with the EMC specifications is no longer guaranteed.

If you remove the RFI jumper, you remove the reliable electrical isolation. In other words, all controlled inputs and outputs become low-voltage terminals with basic electrical isolation. Also, when you remove the internal RFI jumper, the motor drive is no longer electromagnetic compatible (EMC).

- ☑ Do not remove the RFI jumper if the main power is a grounded power system to make EMC filter effective
- ☑ You must remove the RFI jumper when conducting high voltage tests. When conducting a high voltage test for the entire facility, disconnect the main power and the motor if the leakage current is too high.
- ☑ To prevent damage to the drive, you must remove the RFI jumper connected to ground if the AC motor drive is installed on an ungrounded power system or a high resistance-grounded (greater than 30 Ω) power system or a corner grounded TN system.

Remove the control board cover

As shown in Step 1 below, gently press the control board cover. Then, as shown in Step 2, pull it down slowly to remove it.



Step 1



Step 2

Remove cooling fan:

To remove the cooling fan of Frame B, gently release the clips on both sides of the cooling fan.



1.2 Preparation for Installation and Wiring

1.2.1 Ambient Conditions

Install the AC motor drive in an environment with the following conditions.

Operation	Temperature	-10°C to 50°C (VFD007EL21W & VFD007EL21W-1, fan required). After you install an optional cooling fan, you can increase the operating temperature of these two models up to 50°C without derating.
	Relative Humidity	< 90%, non-condensing
	Atmospheric pressure	86–106 kPa
	Installation Site Altitude	<1000 m
	Vibration	1.0 mm, peak-to-peak value: from 2–13.2 Hz; 0.7–1.0 G, from 13.2–55 Hz; 1.0 G, from 55–512 Hz; compliance with IEC 60068-2-6 standard.
Storage and Transportation	Temperature	-20°C to 60°C (-4°F to 140°F)
	Relative Humidity	< 90%, non-condensing
	Atmospheric pressure	86–106 kPa
	Vibration	1.0 mm, peak-to-peak value: from 2–13.2 Hz; 0.7–1.0 G, from 13.2–55 Hz; 1.0 G, from 55–512 Hz; compliance with IEC 60068-2-6 standard.
Pollution Degree	2: good for a factory type environment.	

Minimum Mounting Clearance

← (Blue arrow) Inflow

→ (Red arrow) Outflow

↔ (Black) Distance

Single Drive Installation

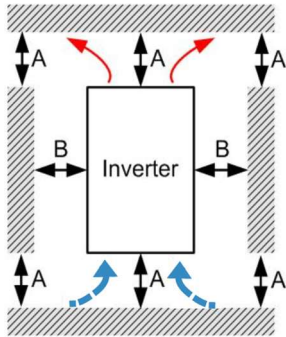

Side-by-Side Horizontal Installation

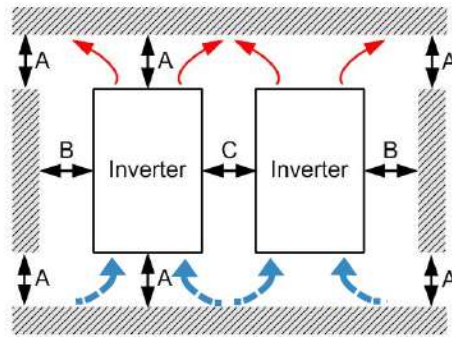

Zero-stack Installation

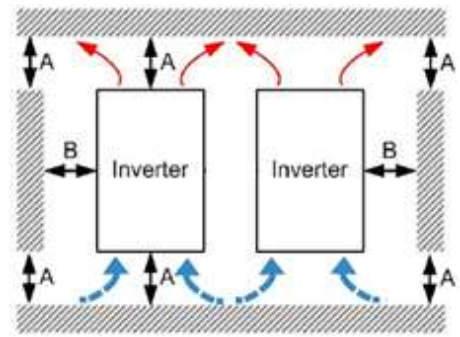

Model Name	Installation Method	Minimum Distance (mm)			Temperature °C	
		A	B	C ^{Note 1}	Max.(Derating is not required) ^{Note 3}	Max.(Derating is required)
VFD002EL21W(-1)	Single Drive	120	50	-	50	60
VFD004EL21W(-1)	Side-by-Side Horizontal	120	50	30	50	60
VFD004EL43W(-1)	Zero-stack ^{Note 2}	-	-	-	-	-
VFD007EL21W(-1)	Single Drive	120	50	-	50 ^{Note 4}	60
	Side-by-Side Horizontal	120	50	30	50 ^{Note 4}	60
	Zero-stack ^{Note 2}	-	-	-	-	-
VFD007EL43W(-1) VFD015EL43W(-1)	Single Drive	120	50	-	50	60
	Side-by-Side Horizontal	120	50	30	50	60
	Zero-stack	-	-	-	-	-
VFD015EL21W(-1)	Single Drive	150	50	-	50	60
VFD022EL21W(-1) VFD022EL43W(-1)	Side-by-Side Horizontal	150	50	30	50	60
VFD040EL43W(-1)	Zero-stack	150	50	0	40	50

 **NOTE**

1. Due to a small protruding part of the heat-sink at the bottom of the Frame A1/ A2, we calculate the distance C for the side-by-side horizontal installation according to the main part of the motor drive only.
2. Frame A1 and A2 does not support zero-stack installation, whereas Frame B supports zero-stack installation.
3. Running the drive continuously with full load by the ambient temperature listed in the “Max. (Derating is not requiered)” column reduces the drive’s life span.
4. After installing a cooling fan to VFD007EL21W(-1), the operating temperature of this model is as shown in the table above. When VFD007EL21W(-1) doesn’t have cooling fan, its operating temperature should be 10 °C lower than the temperature shown above (See Cooling Fan Installation in Appendix B.4).

CAUTION!

1. Mount the AC motor drive vertically on a flat vertical surface with screws. Other mounting directions are not allowed.
2. The AC motor drive generates heat during operation. Allow sufficient space around the unit for heat dissipation. When you install the AC motor drive in a confined space (for example a cabinet), the surrounding temperature must be meet specifications of operation (as shown in chapter 1.2.1) with good ventilation. DO NOT install the AC motor drive in a space with poor ventilation.
3. The heat sink temperature may rise to 90°C when running. The metallic material on which the AC motor drive is mounted must be noncombustible, be excellent at thermal dissipation and be able to withstand this high temperature.
4. When installing multiple AC motor drives in the same cabinet, mount them in a row with enough space between for ventilation. When installing one AC motor drive below another one, use a metal separator between the AC motor drives to prevent mutual heating.

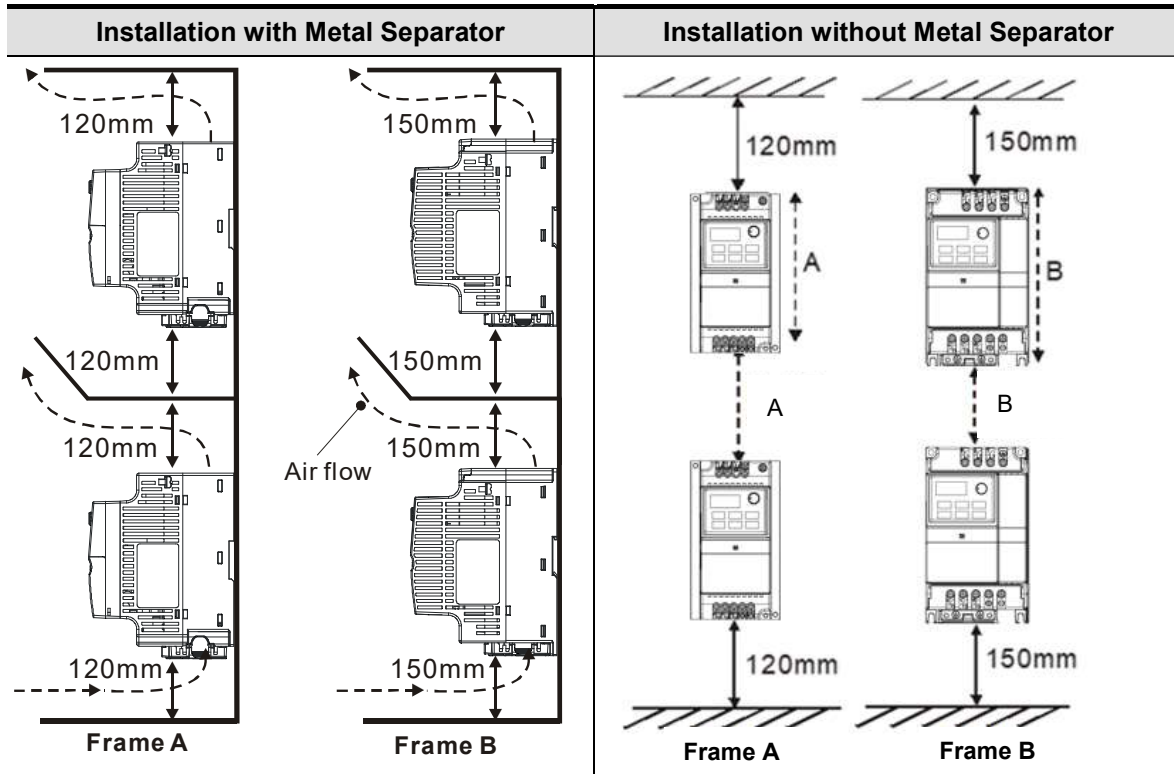

NOTE

- Prevent fiber particles, scraps of paper, shredded wood, sawdust, metal particles, etc. from adhering to the heat sink.
- Install the AC motor drive in a metal cabinet to prevent the risk of fire accident.

1.3 Dimensions

Frame A1

VFD002EL21W(-1), VFD004EL21W(-1), VFD004EL43W(-1), VFD007EL21W(-1), VFD007EL43W(-1)

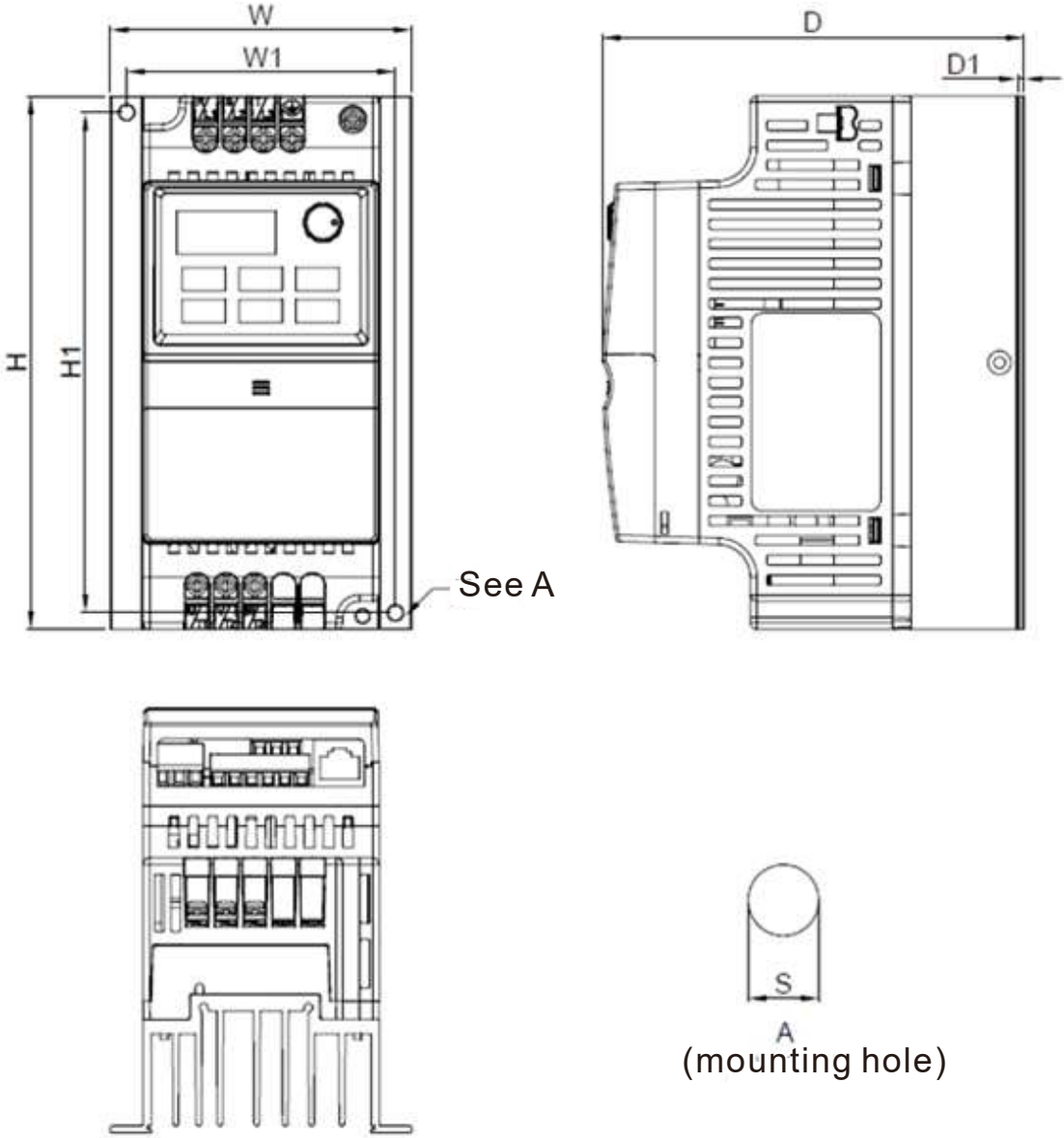

Unit: mm [inch]

Frame	W	W1	H	H1	D	D1	S1
A1	92.0 [3.62]	82.0 [3.23]	162.0 [6.38]	152 [5.98]	128.7 [5.07]	5.4 [0.21]	5.4 [0.21]

Frame A2

VFD015EL43W(-1)

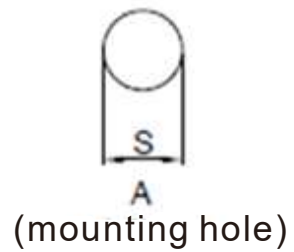
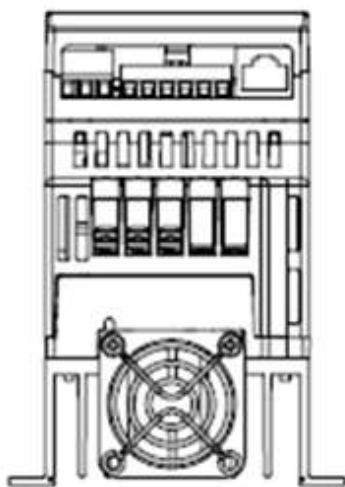
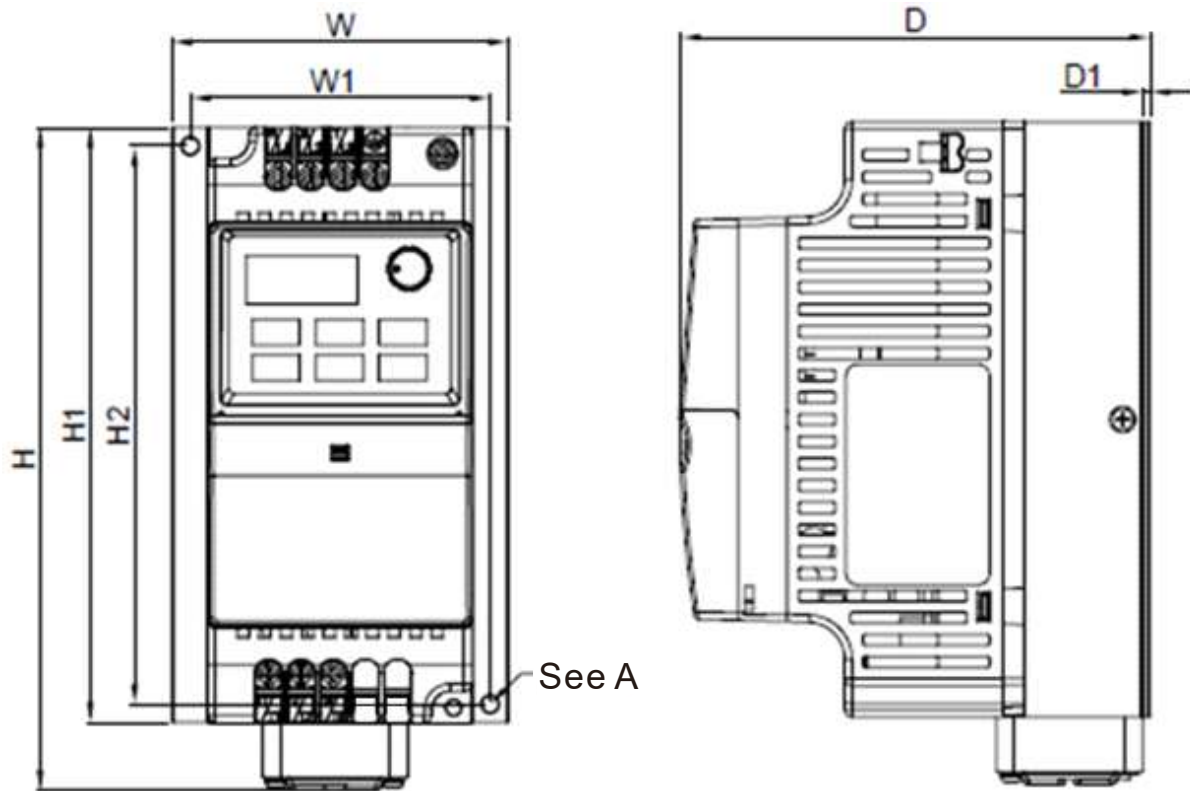

Unit: mm [inch]

Frame	W	W1	H	H1	H2	D	D1	S1
A2	92.0 [3.62]	82.0 [3.23]	180.5 [7.11]	162.0 [6.38]	152 [5.98]	128.7 [5.07]	2.0 [0.08]	5.4 [0.21]

Frame B

VFD015EL21W(-1), VFD022EL21W(-1), VFD022EL43W(-1), VFD040EL43W(-1)

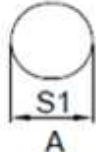
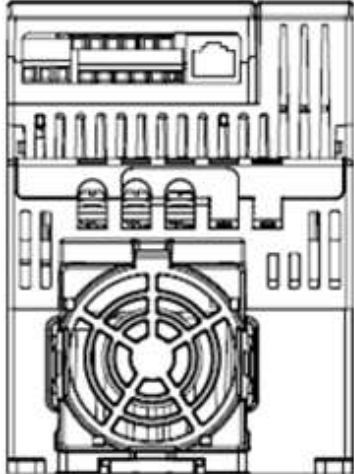
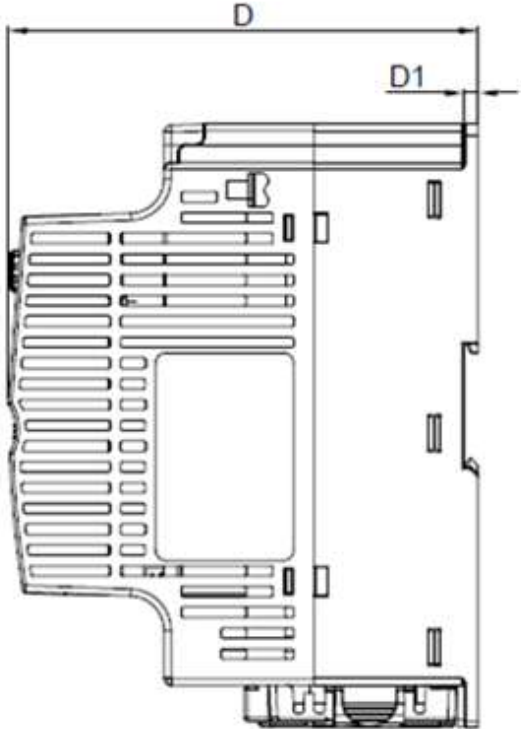
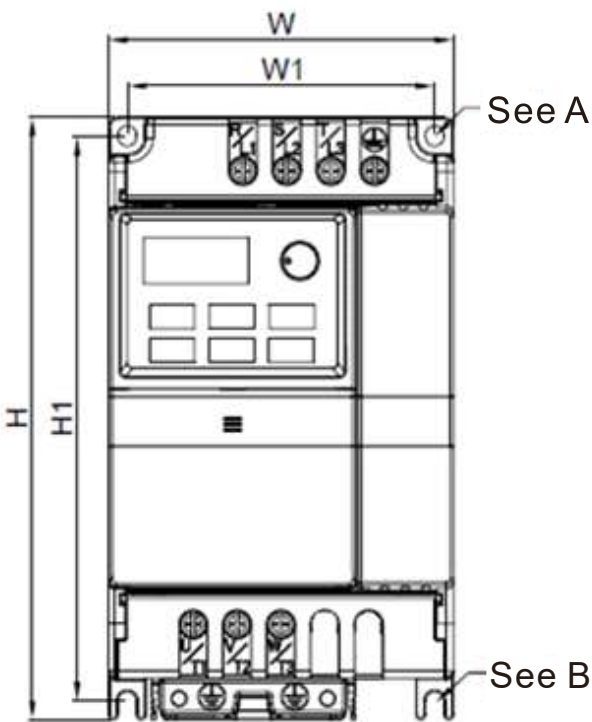

(mounting hole)

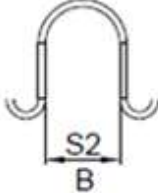

(mounting hole)

Unit: mm [inch]

Frame	W	W1	H	H1	D	D1	S1	S2
B	100.0 [3.94]	89.0 [3.50]	174.0 [6.86]	162.9 [6.42]	136.0 [5.36]	4.0 [0.16]	5.9 [0.23]	5.4 [0.21]

This page intentionally left blank

Chapter 2 Installation and Wiring

2.1 Wiring

2.2 External Wiring

2.3 Main Circuit

2.4 Control Terminals

2.5 NPN / PNP Mode

After removing the covers of input/output side terminals and control board terminals, verify the main circuit terminals and control circuit terminals are clear. Be sure to observe the following precautions when wiring.



- Turn off the AC motor drive power before installing any wiring. A hazardous charge may still remain in the DC bus capacitors after the power has been turned off. For your safety, wait until the digital keypad indicator turns off and measure the DC voltage with the voltmeter. Make sure the voltage drops to a safe level $< 25 V_{DC}$ before wiring. Performing a wiring installation while voltage remains may cause sparks and short circuits.
- Only qualified personnel familiar with AC motor drives are allowed to do the wiring. Make sure the power is turned off before wiring to prevent electric shock.
- Make sure that power is only applied to the R/L1, S/L2, and T/L3 terminals. Failure to comply may result in damage to the equipment. The voltage and current should be in the range on the AC motor drive nameplate. (refer to Section 1-1 Receiving and Inspection for details)
- The grounding terminals must be well-grounded to prevent electric shock or fire accidents and to reduce noise interference.
- Make sure that you correctly tighten the main circuit terminal screws to prevent sparks that can be caused by screws loosened due to vibration.



- When wiring, choose wires that comply with local regulations for your safety.
- Check following items after finishing the wiring:
 1. Are all connections correct?
 2. Are there any loose wires?
 3. Are there any short circuits between the terminals or to ground?

2.1 Wiring

There are wirings for main circuits and control circuits. You must wire according to the following wiring diagrams.

■ 230V One-phase

VFD002EL21W(-1), VFD004EL21W(-1), VFD007EL21W(-1), VFD015EL21W(-1), VFD022EL21W(-1)

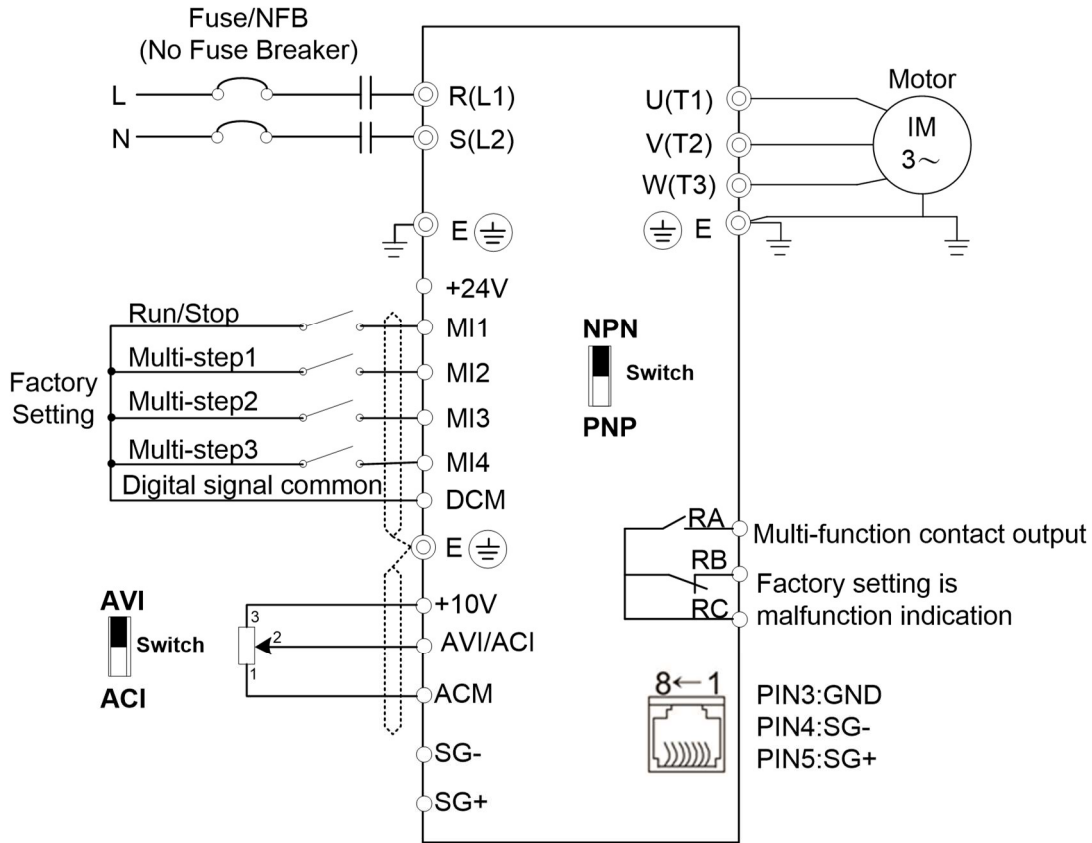

◎ Main circuit (power) terminals ○ Control circuit terminals ⊞ Shielded leads & cable

NOTE Terminal SG+, SG- are joined to PIN5, PIN4 of RJ45 Connector

■ 460V Three-phase

VFD004EL43W(-1), VFD007EL43W(-1), VFD015EL43W(-1), VFD022EL43W(-1), VFD040EL43W(-1)

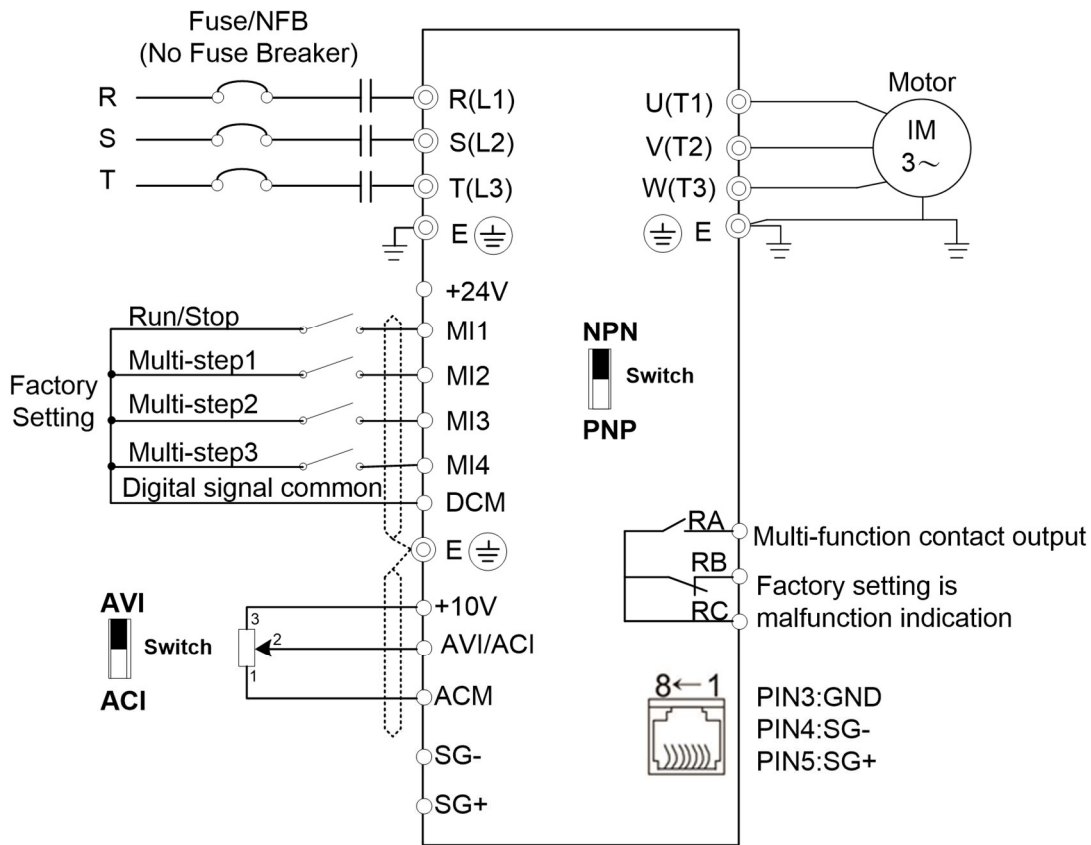

⊙ Main circuit (power) terminals ○ Control circuit terminals ⊕ Shielded leads & cable

NOTE Terminal SG+,SG- are joined to PIN5,PIN4 of RJ45 Connector

Wiring for NPN and PNP mode

Internal power supply

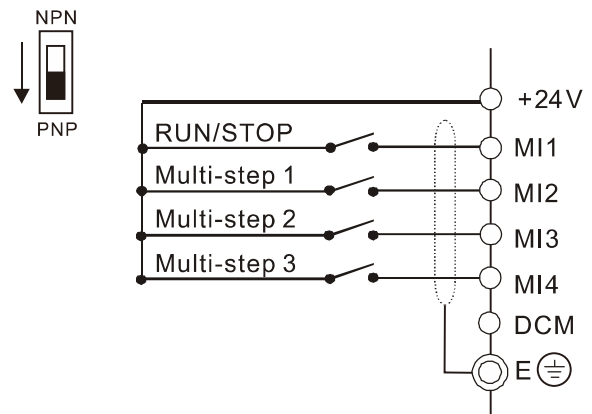
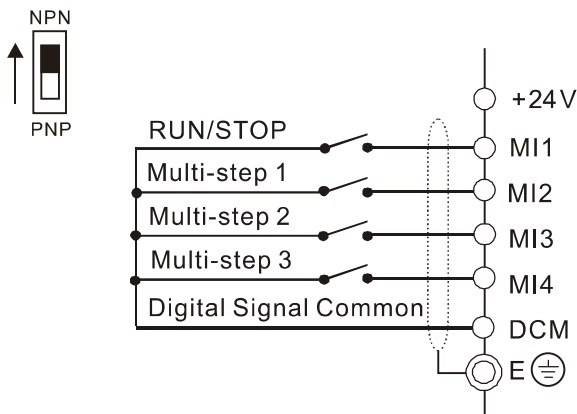

External power supply

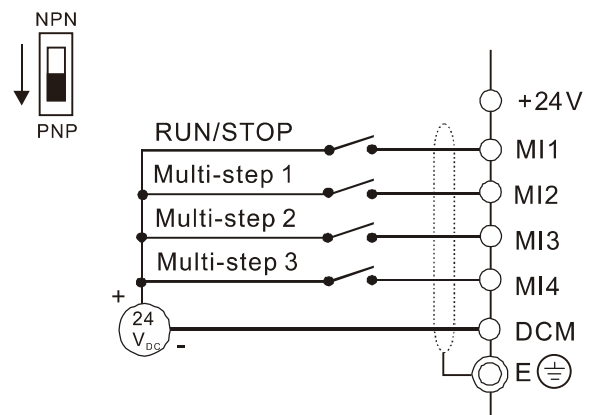
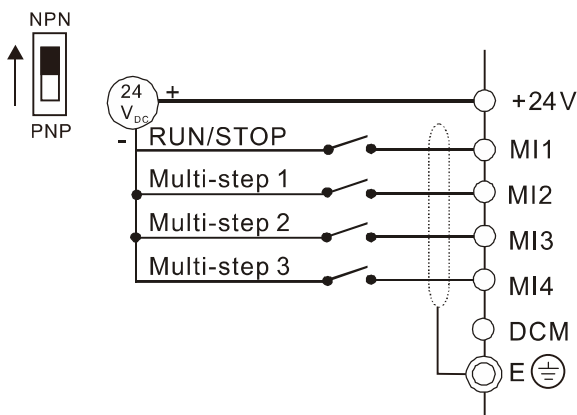

1. Separate the main circuit and control circuit wiring to prevent erroneous actions.
2. Use shielded wire for the control wiring and do not expose the peeled-off shield in front of the terminal.
3. Use shielded wire or conduit for the power wiring and ground the two ends of the shielded wire or conduit.
4. Damaged insulation of wiring may cause personal injury or damage to circuits and equipment if it comes in contact with high voltage.
5. The AC motor drive, motor and wiring may cause interference. To prevent equipment damage, take care of interference between the surrounding sensors and the equipment.
6. Connect the AC drive output terminals U/T1, V/T2, and W/T3 to the motor terminals U/T1, V/T2, and W/T3, respectively. To permanently reverse the direction of motor rotation, switch over any of the two motor leads.
7. With long motor cables, high capacitive switching current peaks can cause over-current, high leakage current or lower current readout accuracy. To prevent this, the motor cable should be less than 20 m for 4.0 kW models and below. The cable should be less than 50 m for 5.5 kW models and above. For longer motor cables, use an AC output reactor.
8. The AC motor drives, electric welding machines and the larger horsepower motors should be grounded separately.
9. Use ground leads that comply with local regulations and keep them as short as possible.
10. The VFD-EL-W series does not have a built-in brake unit, and no support for external brake unit and brake resistor.
11. When grounding, choose wires that comply with local regulations for your safety.
12. To prevent lightning strike and electric shock, the metal grounding wire of electrical equipment should be thick and short, and connected to the dedicated grounding terminal of the inverter system.
13. You can install multiple VFD-EL-W units in one location. All the units should be grounded directly to a common ground terminal, as shown in the figure below. **Ensure that there are no ground loops.**

Excellent grounding method:

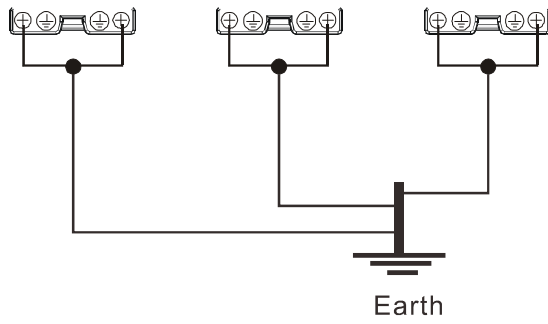

Acceptable grounding method:

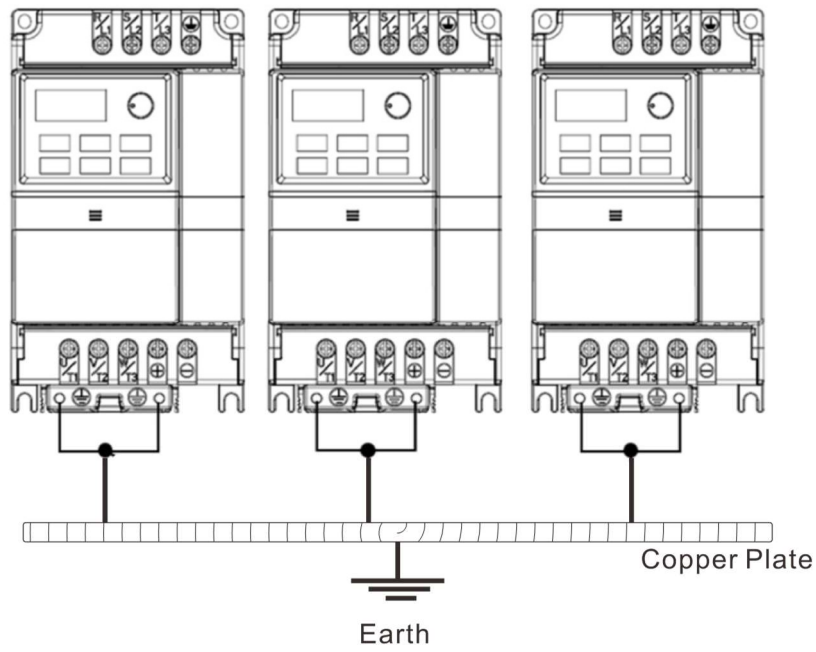

Grounding method not allowed:

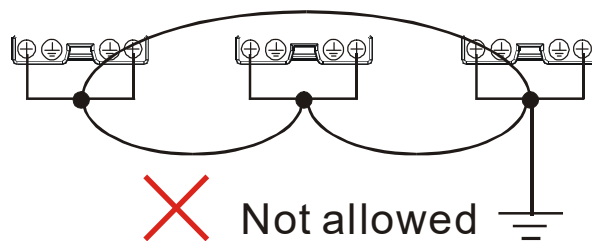

2.2 External Wiring

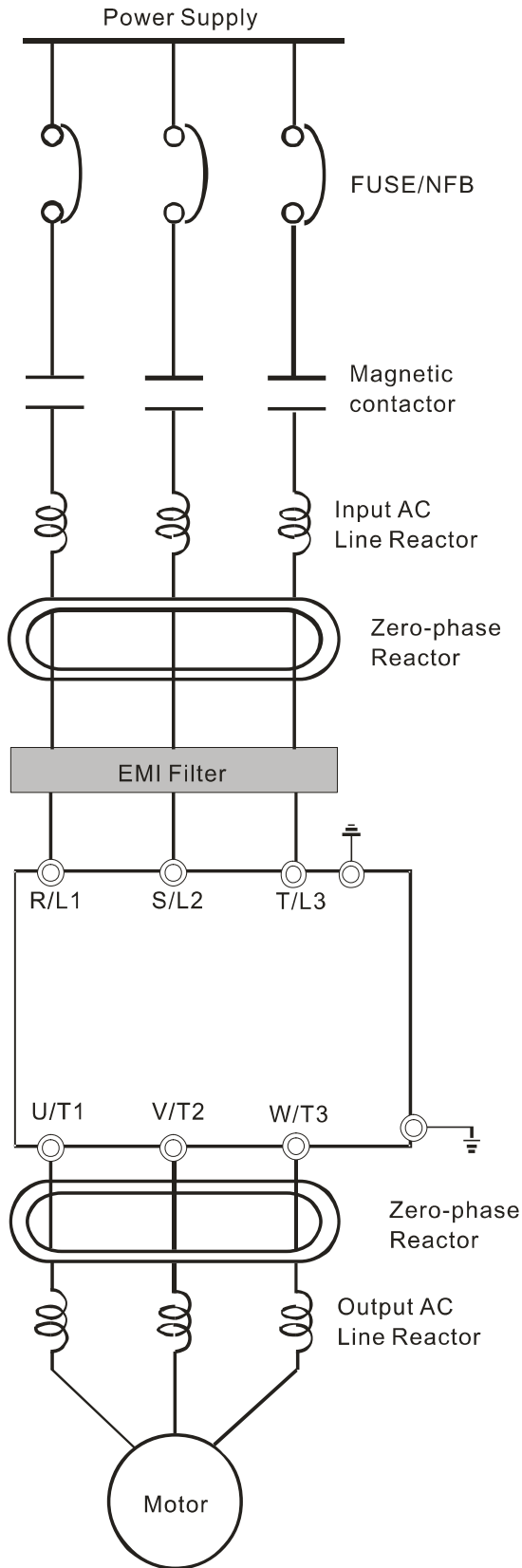

Items	Explanations
Power supply	Please follow the specific power supply requirements in Appendix A.
Fuse/NFB (optional)	There may be an inrush current during power-up. Please check the chart in Appendix B and select the correct fuse for the rated current. Use of an NFB is optional.
Magnetic contactor (optional)	Do not use a magnetic contactor as the I/O switch for the AC motor drive, as it will reduce the operating life of the AC drive.
Input AC Line Reactor (optional)	Use to improve the input power factor, reduce harmonics and provide protection from AC line disturbances (such as surges, switching spikes, short interruptions). Install an AC line reactor when the power supply capacity is 500 kVA or more, or advanced capacity is activated. The wiring distance should be $\leq 10\text{m}$. Refer to Appendix B for details.
Zero-phase Reactor (Ferrite Core Common Choke) (optional)	Use zero phase reactors to reduce radio noise, especially when audio equipment is installed near the inverter. They are effective for noise reduction on both the input and output sides. Attenuation quality is good for a wide range from the AM band to 10 MHz. Appendix B lists the specifications for zero-phase reactors (RF220X00A).
EMI filter	Use to reduce electromagnetic interference.
Output AC Line Reactor (optional)	Motor surge voltage amplitude depends on motor cable length. For applications with long motor cable ($>20\text{ m}$), install a reactor at the inverter output side.

2.3 Main Circuit

2.3.1 Main Circuit Connection

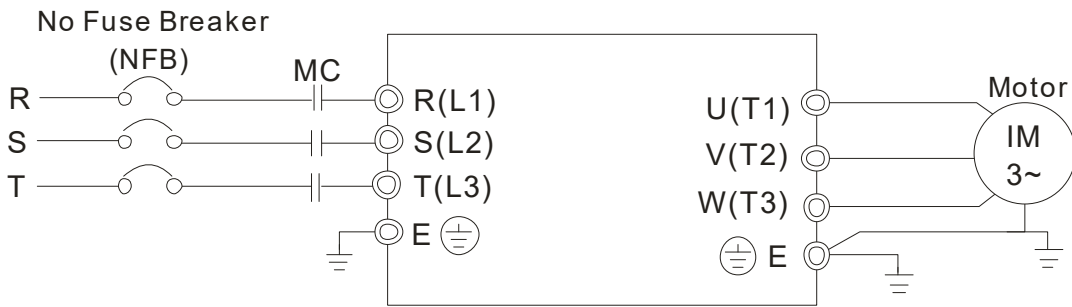

Terminal Symbol	Explanation of Terminal Function
R/L1, S/L2, T/L3	Mains input terminals (one-phase/three-phase)
U/T1, V/T2, W/T3	Motor drive output terminals for connecting three-phase induction motor
⊕	Ground connection. Please comply with local regulations.



Mains power terminals (R/L1, S/L2, T/L3)

- Do NOT connect three-phase motor drives to single-phase AC power. There is no sequential order when connecting mains power terminals R/L1, S/L2, T/L3. Connect these terminals with a freely usable standard.
- Connect terminals (R/L1, S/L2, and T/L3) with a non-fuse breaker to three-phase AC power for circuit protection. It is recommended that you add a magnetic contactor (MC) in the power input wiring to cut off power quickly and reduce malfunction when activating the protection function for the AC motor drives. Both ends of the MC should have an R-C surge absorber.
- Make sure that you correctly tighten the main circuit terminal screws to prevent sparks caused by loosening screws due to vibration.
- Use voltage and current levels according to the specifications in Appendix A.
- When using a GFCI (Ground Fault Circuit Interrupter), select a current sensor with sensitivity of 200 mA or higher, and not less than 0.1 second operation time to avoid nuisance tripping. For specific GFCI of the AC motor drive, select a current sensor with sensitivity of 30 mA or higher.
- Do NOT run or stop AC motor drives by turning the power ON or OFF. Use the RUN or STOP command through the control terminals or a keypad. If you still need to run or stop the AC drives by turning the power ON or OFF, it is recommended to do so no more often than ONCE per hour.

Output terminals for main circuit (U, V, W)

- The default for the operation direction is running forward. The method to control the running direction is to set by the communication parameters. Refer to the Parameter Group 09 in Chapter 4 for details.
- When it is necessary to install the filter at the output side of terminals U/T1, V/T2, W/T3 on the AC motor drive, use an inductance filter. Do not use phase-compensation capacitors or L-C (Inductance-Capacitance) or R-C (Resistance-Capacitance), unless approved by Delta.
- DO NOT connect phase-compensation capacitors or surge absorbers at the output terminals of AC motor drives.
- Use a well-insulated motor, suitable for inverter operation.

2.3.2 Main Circuit Terminals

Frame A1

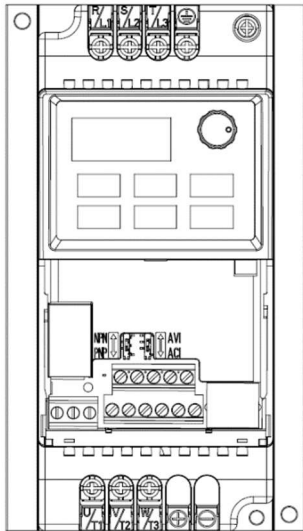

Frame A2

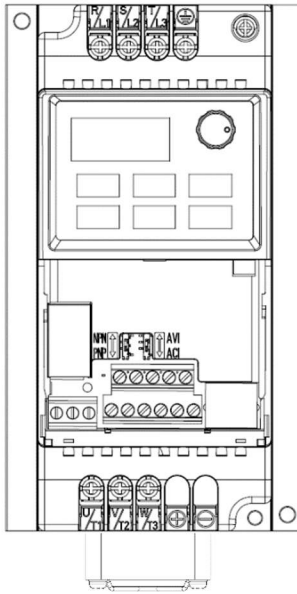

Frame B

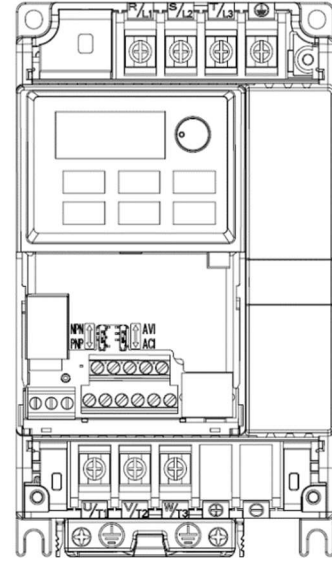

Frame	Model	Main Circuit Terminals R/L1, S/L2, T/L3, U/T1, V/T2, W/T3, ⏏		
		Maximum Wire Gauge	Minimum Wire Gauge	Screw Size Tightening Torque ($\pm 10\%$)
A1	VFD002EL21W(-1)	4 mm ² [12 AWG]	2.5 mm ² [14 AWG]	M4 screw 15 kgf-cm [13 lbf-in] [1.47 N-m]
	VFD004EL21W(-1)			
	VFD004EL43W(-1)			
	VFD007EL21W(-1)		4 mm ² [12 AWG]	
	VFD007EL43W(-1)		2.5 mm ² [14 AWG]	
A2	VFD015EL43W(-1)			
B	VFD015EL21W(-1)	10 mm ² [8 AWG]	10 mm ² [8 AWG]	M4 screw 13 kgf-cm [11.4 lbf-in] [1.3 N-m]
	VFD022EL21W(-1)			
	VFD022EL43W(-1)		2.5 mm ² [14 AWG]	
	VFD040EL43W(-1)			

NOTE

- For installation at an ambient temperature of 50°C, select copper wires with temperature resistance of 75°C or 90°C. For installation at an ambient temperature over 50°C, select copper wires with temperature resistance of 90°C or above.
- For installation of VFD007EL21W(-1) at an ambient temperature of 40°C, select copper wires with temperature resistance of 75°C or 90°C. For installation at an ambient temperature over 40°C, select copper wires with temperature resistance of 90°C or above.
- When installing VFDxxxEL21W(-1), select wires with voltage rating of 300V_{AC} or above. When installing VFDxxxEL43W(-1), select wires with voltage rating of 600V_{AC} or above.

2.4 Control Terminals

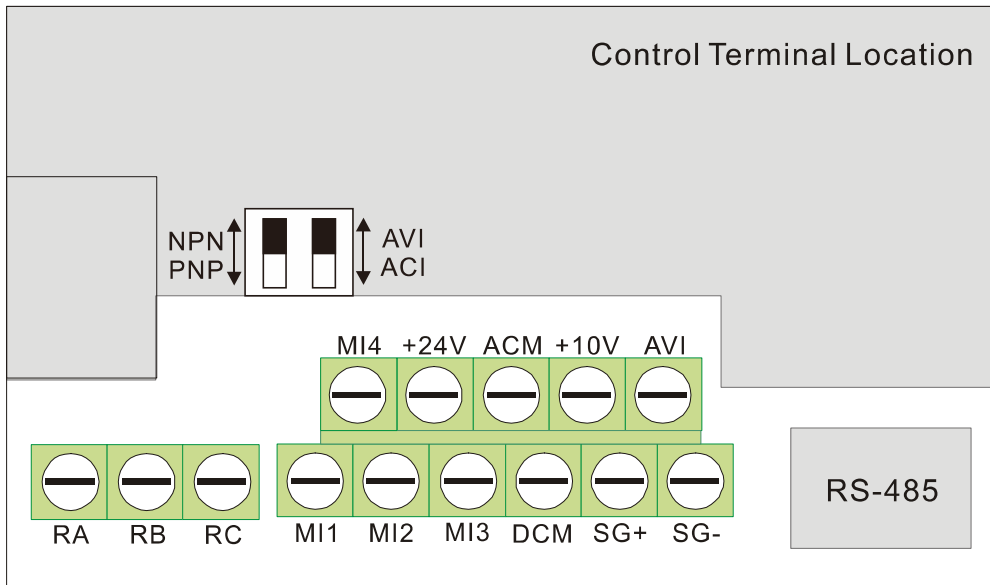

Terminal symbols and functions

Terminal Symbol	Terminal Function	Defaults (NPN mode) ON: Connect to DCM
MI1	Run-Stop Command	ON: Run in MI1 direction OFF: Stop acc. to Stop Method
MI2	Multi-function Input 2	Refer to Pr.04.06 to Pr.04.08 for programming the multi-function inputs. ON: the activation current is 5.5 mA. OFF: leakage current tolerance is 10 μ A.
MI3	Multi-function Input 3	
MI4	Multi-function Input 4	
+24V	DC Voltage Source	The common terminal is only used for a multi-function input terminal. Output voltage: 23–25V, load capacity: 20 mA +24V terminal is only used for digital control signal common when in the internal power supply PNP mode. (Or used for digital control signal common when in the external power supply NPN mode.) For detailed wiring instructions, refer to NPN and PNP mode description.  NOTE Do not use the +24V terminal for other external power loads to avoid damage to the hardware circuit.
DCM	Digital Signal Common (Sink)	Common for multi-function input terminals.
SG+	Modbus RS-485	Internally connected to RJ45 terminal PIN5 and PIN4, providing flexible choice for users (only support one of them at one time).
SG-		
RA	Multi-function Relay Output (N.O.) a	Resistive Load: 5A (N.O.) / 3A (N.C.) 240 V _{AC}
RB	Multi-function Relay Output (N.C.) b	5A (N.O.) / 3A (N.C.) 24 V _{DC} Inductive Load:

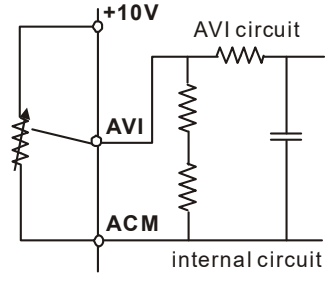
Terminal Symbol	Terminal Function	Defaults (NPN mode) ON: Connect to DCM
RC	Multi-function Relay Common	1.5A (N.O.) / 0.5A (N.C.) 240 V _{AC} 1.5A (N.O.) / 0.5A (N.C.) 24 V _{DC} Refer to Pr.03.00 for programming
+10V	Potentiometer Power Supply	+10 V _{DC} 3 mA (Variable resistor 3–5 kΩ)
AVI	Analog Voltage Input 	Impedance: 47 kΩ Resolution: 10 bits Range: 0–10 V _{DC} / 4–20 mA = 0–maximum output frequency (Pr.01.00) Selection: Pr.02.00, Pr.02.09, Pr.10.00 Setting: Pr.04.14–Pr.04.17
ACM	Analog Control Signal (Common)	Common for AVI

 **NOTE** Control signal wiring size: 18 AWG (0.75 mm²) with shielded wire.

Analog inputs (AVI, ACM)

- Analog input signals are easily affected by external noise. Use shielded wiring and keep it as short as possible (<20 m) with proper grounding. If the noise is inductive, connecting the shield to the ACM terminal can cause improvement.
- If the analog input signals are affected by noise from the AC motor drive, connect a capacitor (0.1 μF and above) and a ferrite core as shown in the following diagrams:

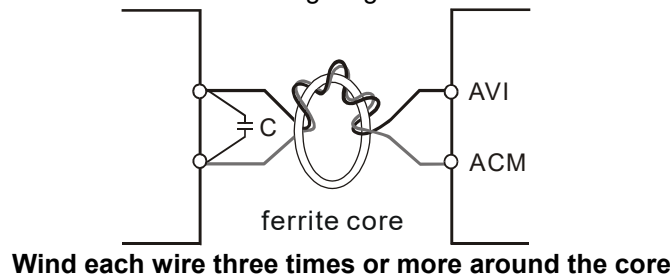

Digital inputs (MI1, MI2, MI3, DCM)

- When using contacts or switches to control the digital inputs, use high-quality components to avoid contact bounce.

Specification for the control terminals

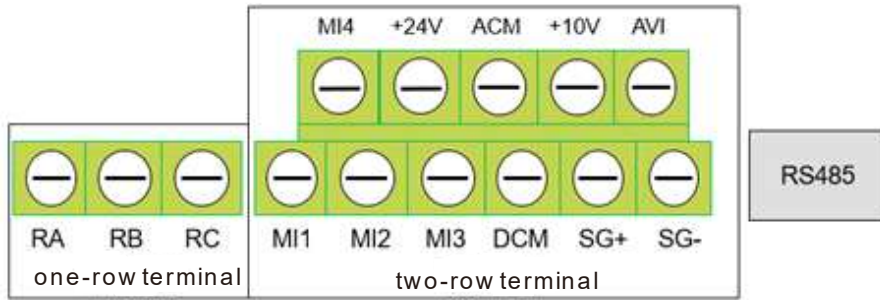

Frame	Model	Wire	One-row terminal torque (±10%)	Two-row terminal (±10%)
A1	VFD002EL21W(-1)	16~24 AWG [1.3~0.2mm ²]	4 kgf-cm [3.5 lbf-in] [0.4 N-m]	7 kgf-cm [6.2lbf-in] [0.7 N-m]
	VFD004EL21W(-1)			
	VFD004EL43W(-1)			
	VFD007EL21W(-1)			
	VFD007EL43W(-1)			
A2	VFD015EL43W(-1)			
B	VFD015EL21W(-1)			
	VFD022EL21W(-1)			
	VFD022EL43W(-1)			
	VFD040EL43W(-1)			

2.5 NPN / PNP Mode

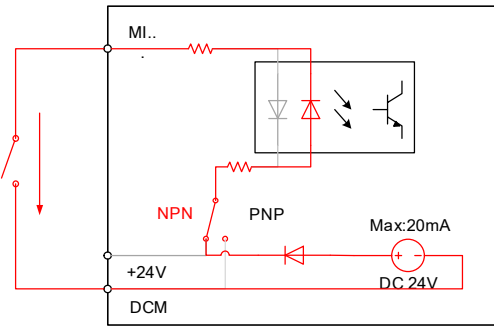
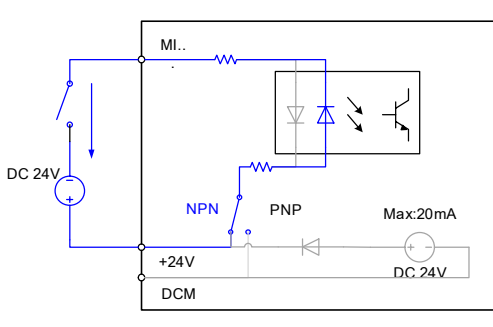
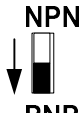
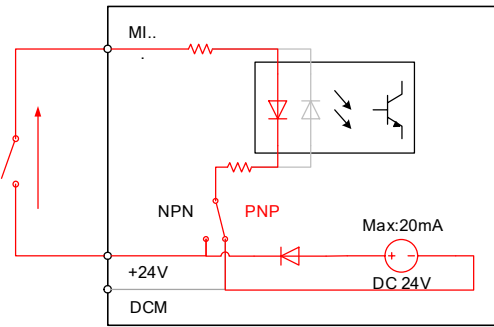
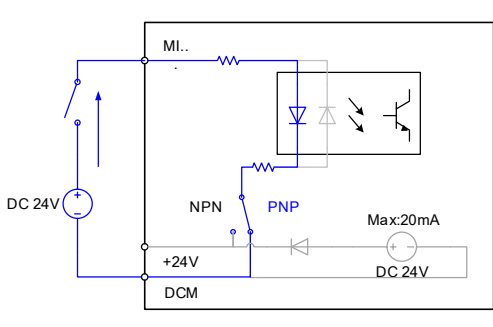
NPN/PNP	Internal power supply	External power supply
<p style="text-align: center;">  NPN PNP SWITCH NPN/Sink Switch- NPN </p>		
<p style="text-align: center;">  NPN PNP SWITCH PNP/Source Switch-PNP </p>		

 **NOTE**

- 1) The total load capacity of +24V-DCM internal 24V power is 60 mA, and only supplies power for the MI terminal of NPN and PNP mode. If you want to know available load capacity to support other external accessories, deduct the load consumed by corresponding MI terminals. Each MI terminal consumes 6mA.
- 2) The power supply of the cooling fan is 24V_{DC}. Internal power is applied from terminal +24V/DCM. Once you install a cooling fan on VFD007EL21W(-1), do not connect any other external accessory to avoid overload on terminal +24V which will damage the motor drive.

This page intentionally left blank.

Chapter 3 Keypad and Start-up

3.1 Description of the Digital Keypad

3.2 Operation Method

3.3 Trial Run



- ☑ Make sure that the wiring is correct. In particular, ensure that the output terminals U/T1, V/T2, W/T3 are NOT connected to power and that the drive is well grounded.
- ☑ Verify that no other equipment is connected to the AC motor drive.
- ☑ Do NOT operate the AC motor drive with wet hands.
- ☑ Please check if the digital keypad displays F60.0 or F50.0 is ON when power is applied.



- ☑ Stop the motor when a fault occurs during running and refer to Chapter 6 Fault Code Information and Maintenance for solutions. DO NOT touch output terminals U, V, W when power is still applied to L1/R, L2/S, L3/T, even when the AC motor drive is stopped to prevent electric shock.

3.1 Description of the Digital Keypad

VFD-EL-W series operates the running and displays the functions by the digital keypad.



① Status Display

Displays the drive's current status: RUN, STOP, FWD, REV

② LED Display

Indicates frequency, current, voltage, running direction, user-defined units, faults, etc.

③ Potentiometer

Sets the master frequency













④ UP / DOWN Key

Selects parameters and sets / changes parameter settings

There are four LEDs on the keypad

- STOP : Lights when the drive stops.
- RUN : Lights when the motor is running.
- FWD : Lights when the motor is running forward.
- REV : Lights when the motor is running in reverse.

Description of the Displayed Functions

Display Function	Description
 RUN ● STOP FWD ● REV ●	Displays current setting frequency of the AC motor drive.
 RUN ● STOP FWD ● REV ●	Displays the actual output frequency to the motor.
 RUN ● STOP FWD ● REV ●	Displays the user-defined unit (where $U = F \times Pr.00.05$)
 RUN ● STOP FWD ● REV ●	Displays the loading current.
 RUN ● STOP FWD ● REV ●	FWD command.
 RUN ● STOP FWD ● REV ●	REV command.
 RUN ● STOP FWD ● REV ●	The counter value (C).
 RUN ● STOP FWD ● REV ●	Displays the selected parameter.
 RUN ● STOP FWD ● REV ●	Displays the actual stored value of the selected parameter.
 RUN ● STOP FWD ● REV ●	Displays the external fault.
 RUN ● STOP FWD ● REV ●	Displays "End" for approximately one second (as shown in the left figure) if the data has been accepted and automatically stored in the register.
 RUN ● STOP FWD ● REV ●	Displays if the setting data is not accepted or data value exceeds the allowed range.

Keypad Operation Process

Setting Mode

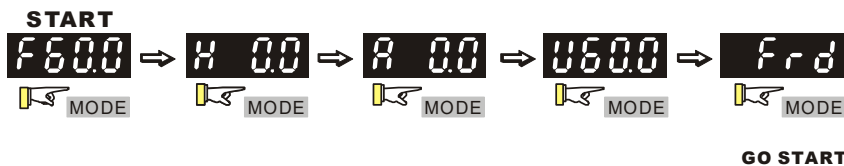

NOTE: In the selection mode, press to set the parameters.

Setting parameters



NOTE :In the parameter setting mode, you can press to return the selecting mode.

To shift data



Setting direction (When operation source is digital keypad)

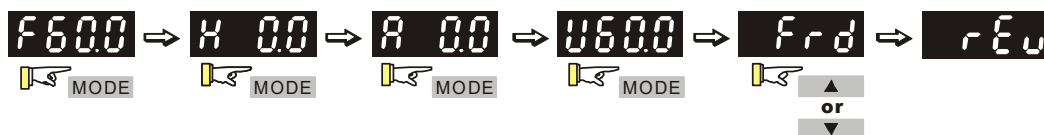

Reference Table for the Seven-segment LED Display of the Digital Keypad

Digit	0	1	2	3	4	5	6	7	8	9
LED Display	0	1	2	3	4	5	6	7	8	9
English alphabet	A	b	Cc	d	E	F	G	Hh	li	Jj
LED Display	A	b	Cc	d	E	F	G	Hh	li	Jj
English alphabet	K	L	n	Oo	P	q	r	S	Tt	U
LED Display	K	L	n	Oo	P	q	r	S	Tt	U
English alphabet	v	Y	Z							
LED Display	v	Y	Z							

3.2 Operation Method

You can set Pr.02.01 to select the operation method to be through the digital keypad, RS-485 communication or control terminals.

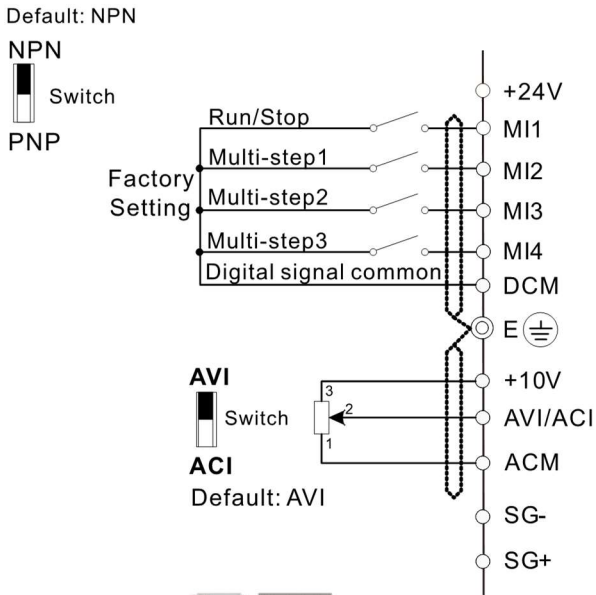

Operation Method	Frequency Source	Operation Command Source
Operate through communication	When using communication from the PC, use an IFD6500 / IFD6530 or IFD8500 converter to connect the drive to the PC. Refer to the communication address 2000H and 2101H setting for details.	
Operate through the digital keypad	<div style="text-align: center;">  <p>Figure 3-1</p> </div> <div style="display: flex; justify-content: space-between;"> <div data-bbox="432 808 938 969"> Set the frequency source through the ▲ ▼ keys, as shown in Figure 3-1. </div> <div data-bbox="946 808 1447 969"> Set the operation command source through the RUN, STOP / RESET keys, as shown in Figure 3-1. </div> </div>	
Operate through external signals	<div style="text-align: center;">  <p>Figure 3-2</p> </div> <div style="text-align: center;"> <p>NOTE</p> <p>Terminal SG+, SG- are joined to PIN5, PIN4 of RJ45 connector</p> </div> <div style="display: flex; justify-content: space-between; margin-top: 20px;"> <div data-bbox="432 1765 938 1975"> MI3-DCM (Set Pr.04.05=d10) MI4-DCM (Set Pr.04.06=d11) </div> <div data-bbox="946 1765 1447 1975"> Set MI1-DCM as Run / Stop. Refer to the parameter descriptions in Chapter 04 for details of FWD/REV operations. </div> </div>	

3.3 Trial Run

The default for the operation source is the digital

keypad. The setting methods are as follows:

- ☑ After applying power, verify that the LED display shows F 60.0 Hz.
- ☑ Press  key to set the frequency to be around 5 Hz. (Refer to Figure 3-1)
- ☑ If you want to change FWD to REV, press MODE to find the FWD function, then press the UP or DOWN key to locate the REV function to finish the direction change.
- ☑ Check following items:
 - Check if the motor rotation direction is correct.
 - Check if the motor runs steadily without abnormal noise and vibration.
 - Check if acceleration and deceleration are smooth.

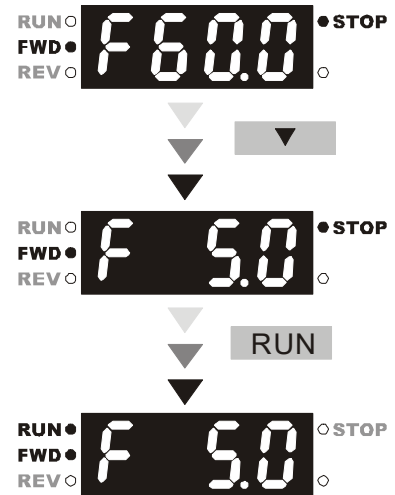

If the results of trial run are normal, increase the operating frequency to continue the trial run. If the trial run still goes normally, then you can start the formal run.

Motor operating direction

When the AC drive output terminals U/T1, V/T2 and W/T3 are connected to the motor terminals U/T1, V/T2 and W/T3 respectively, the FWD LED indicator on the digital keypad is ON. This means the AC motor drive executes running forward, and the motor rotates as the figure below shows. On the contrary, when the REV LED indicator lights, the AC motor drive executes running in reverse, and the motor rotates in an opposite direction as the figure below shows. If the AC motor drive executes running forward but the motor rotates in a reverse direction, exchange any two of the U/T1, V/T2 and W/T3 motor terminals.

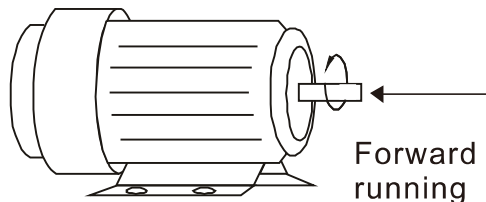

Figure 3-3

This page intentionally left blank.

4.1 Summary of Parameter Settings

4.2 Parameter Settings for Applications

4.3 Description of Parameter Settings

The VFD-EL-W parameters are divided into 11 groups by property for easy setting. In most applications, the user can finish all parameter settings before start-up without the need for re-adjustment during operation.

The 11 groups are as follows:

Group 0:	User Parameters
Group 1:	Basic Parameters
Group 2:	Operation Method Parameters
Group 3:	Output Function Parameters
Group 4:	Input Function Parameters
Group 5:	Multi-Step Speed Parameters
Group 6:	Protection Parameters
Group 7:	Motor Parameters
Group 8:	Special Parameters
Group 9:	Communication Parameters
Group 10:	PID Control Parameters

4.1 Summary of Parameter Settings

↗: You can set this parameter during operation.

Group 0 User Parameters

Parameter	Function	Setting	Default	Customer
00.00	Identity Code of the AC motor drive	0: 230V, 0.25HP 2: 230V, 0.5HP 3: 460V, 0.5HP 4: 230V, 1 HP 5: 460V, 1 HP 6: 230V, 2 HP 7: 460V, 2 HP 8: 230V, 3 HP 9: 460V, 3 HP 11: 460V, 5.5 HP	Read only	
00.01	Rated Current Display of the AC motor drive	Read only	Read only	
00.02	Parameter Reset	0: Parameter can be read/written 1: All parameters are read only 8: Keypad lock 9: All parameters are reset to default (50 Hz, 230V/400V or 220V/380V depends on Pr.00.12) 10: All parameters are reset to default (60 Hz, 220V/440V)	0	
↗00.03	Start-up Display Selection	0: F (frequency command) 1: H (actual frequency) 2: A (output current) 3: U (user-defined, see Pr.00.04) 4: FWD/REV command	0	
↗00.04	Content of Multi-function Display	0: Display the content of user-defined unit (Uxxx) 1: Display the counter value (c) 2: Display the status of multi-function input terminals (d) 3: Display DC bus voltage (u) 4: Display output voltage (E) 5: Display PID analog feedback signal value (b) (%) 6: Output power factor angle (n) 7: Display output power (P) 8: Display PID setting and feedback signal 9: Display AVI (I) (V) 10: Display ACI (i) (mA) 11: Display the temperature of IGBT (h) (°C)	0	
↗00.05	User-Defined Coefficient K	0.1–160.0	1.0	

Parameter	Function	Setting	Default	Customer
00.06	Software Version	Read only	###	
00.08	Password Input	0-9999 0-2: the number of password attempts allowed	0	
00.09	Password Set	0-9999 0: No password protection / password entered correctly (Pr.00.08) 1: Parameter has been set	0	
00.10	Control Mode	0: V/F control 1: Vector control	0	
00.12	50 Hz Base Voltage Selection	0: 230V/400V 1: 220V/380V	0	
00.13	User-defined value (correspond to max. operating frequency)	0-9999	0	
00.14	Decimal place of User-defined Value	0-3	0	

Group 1 Basic Parameters

Parameter	Function	Setting	Default	Customer
01.00	Maximum Output Frequency (Fmax)	50.00–400.0 Hz	60.00	
01.01	Motor Rated Frequency (Fbase)	0.10–400.0 Hz	60.00	
01.02	Motor Rated Voltage (Vbase)	230V series: 0.1–255.0 V 460V series: 0.1–510.0 V	220.0 440.0	
01.03	Mid-Point Frequency (Fmid)	0.10–400.0 Hz	1.50	
01.04	Mid-Point Voltage (Vmid)	230V series: 0.1–255.0 V 460V series: 0.1–510.0 V	10.0 20.0	
01.05	Minimum Output Frequency (Fmin)	0.10–400.00 Hz	1.50	
01.06	Minimum Output Voltage (Vmin)	230V series: 0.1–255.0 V 460V series: 0.1–510.0 V	10.0 20.0	
01.07	Output Frequency Upper Limit	0.1–120.0%	110.0	
01.08	Output Frequency Lower Limit	0.0–100.0 %	0.0	
↗01.09	Acceleration Time 1 (Taccel 1)	0.1–600.0 / 0.01–600.00 sec.	10.0	
↗01.10	Deceleration Time 1 (Tdecel 1)	0.1–600.0 / 0.01–600.00 sec.	10.0	
↗01.11	Acceleration Time 2 (Taccel 2)	0.1–600.0 / 0.01–600.00 sec.	10.0	
↗01.12	Deceleration Time 2 (Tdecel 2)	0.1–600.0 / 0.01–600.00 sec.	10.0	
↗01.13	Jog Acceleration Time	0.1–600.0 / 0.01–600.00 sec.	1.0	
↗01.14	Jog Deceleration Time	0.1–600.0 / 0.01–600.00 sec.	1.0	
↗01.15	Jog Frequency	0.10–400.0 Hz	6.00	
01.16	Auto-Acceleration and Auto-Deceleration	0: Linear Acceleration and linear deceleration 1: Auto-acceleration and linear deceleration 2: Linear acceleration and auto-deceleration 3: Auto-acceleration and auto-deceleration (Set by load) 4: Auto-acceleration and auto-deceleration (set by Acceleration / Deceleration Time setting)	0	
01.17	Acceleration S-Curve	0.0 (S-curve disabled) 0.1–10.0 / 0.01–10.00	0.0 / 0.00	
01.18	Deceleration S-Curve	[S-curve enabled (10.0/10.00 is the smoothest)]		
01.19	Acceleration / Deceleration Time Unit	0: Unit: 0.1 sec. 1: Unit: 0.01 sec.	0	
↗01.20	Simple Positioning Stop Frequency 0	0.00–400.0 Hz	0.00	
↗01.21	Simple Positioning Stop Frequency 1		5.00	
↗01.22	Simple Positioning Stop Frequency 2		10.00	
↗01.23	Simple Positioning Stop Frequency 3		20.00	
↗01.24	Simple Positioning Stop Frequency 4		30.00	

Parameter	Function	Setting	Default	Customer
↗01.25	Simple Positioning Stop Frequency 5	0.00–400.0 Hz	40.00	
↗01.26	Simple Positioning Stop Frequency 6		50.00	
↗01.27	Simple Positioning Stop Frequency 7		60.00	
↗01.28	Delay Time of Simple Positioning Stop 0	0.00–600.00 sec.	0.00	
↗01.29	Delay Time of Simple Positioning Stop 1		0.00	
↗01.30	Delay Time of Simple Positioning Stop 2		0.00	
↗01.31	Delay Time of Simple Positioning Stop 3		0.00	
↗01.32	Delay Time of Simple Positioning Stop 4		0.00	
↗01.33	Delay Time of Simple Positioning Stop 5		0.00	
↗01.34	Delay Time of Simple Positioning Stop 6		0.00	
↗01.35	Delay Time of Simple Positioning Stop 7		0.00	

Group 2 Operation Method Parameters

Parameter	Function	Setting	Default	Customer
↗02.00	First Master Frequency Command Source	0: Digital keypad UP/DOWN keys or Multi-function Inputs UP/DOWN. 1: 0–10 V from AVI 2: 4–20 mA from ACI 3: RS-485 (RJ45) communication 4: Digital keypad potentiometer	0	
↗02.01	First Operation Command Source	0: Digital keypad 1: External terminals. Keypad STOP/RESET enabled. 2: External terminals. Keypad STOP/RESET disabled. 3: RS-485 communication. Keypad STOP/RESET enabled. 4: RS-485 communication. Keypad STOP/RESET disabled.	0	
02.02	Stop Method	0: STOP: ramp to stop; E.F.: coast to stop 1: STOP: coast to stop; E.F.: coast to stop 2: STOP: ramp to stop; E.F.: ramp to stop 3: STOP: coast to stop; E.F.: ramp to stop 4: Simple Positioning Stop; E.F.: coast to stop	0	
02.03	PWM Carrier Frequency Selection	2–12 kHz	8	
02.04	Motor Direction Control	0: Forward/reverse operation enabled 1: Reverse operation disabled 2: Forward operation disabled	0	
02.05	Power-On Command and Run Command Source Modifies the Drive Operating Control	0: Start running when power is on. 1: Do not run when power is on 2: When the source of the command changes, the drive's operation remains the same. 3: When the source of the command changes, the drive's operation follows the new command. 4: The motor drive can start to run at power on or after reset. When the source of the command is a two-wire external terminal, the operating command changes as the external terminal's status changes.	1	
02.06	Loss of ACI Signal (4–20 mA)	0: Decelerate to 0 Hz 1: Coast to stop and display "AErr" 2: Continue the operation according to the last frequency command 3: Continue the operation according to the setting at Pr.02.11.	0	
02.07	Up/Down Mode	0: Digital keypad up/down keys mode 1: Based on Accel./ Decel. time 2: Constant speed (according to Pr.02.08) 3: Pulse input unit (according to Pr.02.08)	0	

Parameter	Function	Setting	Default	Customer
02.08	Accel./ Decel. Rate of Change of UP/DOWN Operation with Constant Speed	0.01–10.00 Hz / 2ms	0.01	
↗02.09	Second Frequency Command Source	0: Digital keypad UP/DOWN keys or Multi-function Inputs UP/DOWN. 1: 0–10V from AVI 2: 4–20 mA from ACI 3: RS-485 (RJ45) communication 4: Digital keypad potentiometer	0	
↗02.10	Combining the First and Second Master Frequency Commands	0: First Master Frequency Command Only 1: First Master Frequency Command+ Second Master Frequency Command 2: First Master Frequency Command - Second Master Frequency Command	0	
↗02.11	Keypad Frequency Command	0.00–400.0 Hz	60.00	
↗02.12	Communication Frequency Command	0.00–400.0 Hz	60.00	
02.13	Saving Keypad or Communication Frequency Command Selection	0: Save Keypad & Communication Frequency 1: Save Keypad Frequency Only 2: Save Communication Frequency Only	0	
02.14	Initial Frequency Selection (for keypad & RS-485)	0: Current Frequency Command 1: Zero Frequency Command 2: Refer to Pr.02.15 to set up	0	
02.15	Initial Frequency Setting (for keypad & RS-485)	0.00–400.0 Hz	60.00	
02.16	Display the Master Frequency Command Source	Read Only 1: bit0=1: First Master Frequency Source (Pr.02.00) 2: bit1=1: Second Master Frequency Source (Pr.02.09) 4: bit2=1: Multi-function input	Read only	
02.17	Display the Operation Command Source	Read Only 1: bit0=1: Digital Keypad 2: bit1=1: RS-485 communication 4: bit2=1: External Terminal (M11) 8: bit3=1: Multi-function input	Read only	
02.18	User-defined Value 2 Setting	0–Pr.00.13	0	
02.19	User-defined Value 2	0–9999	Read only	

Group 3 Output Function Parameters

Parameter	Function	Setting	Default	Customer
03.00	Multi-function Output Relay (RA1, RB1, RC1)	0: No function 1: Indication during RUN 2: Indication of master frequency reached 3: Zero speed 4: Over-torque detection 5: Base-Block (B.B.) indication 6: Low-voltage indication 7: Operation mode indication 8: Fault indication 9: Desired frequency reached 10: Terminal count value reached 11: Preliminary count value reached 12: Over-voltage stall prevention 13: Over-current Stall prevention 14: IGBT overheat warning (85°C: ON, 80°C: OFF) 15: Over-voltage 16: PID feedback error 17: Forward command 18: Reverse command 19: Zero speed output signal 20: Warning 21: Mechanical brake control (Desired frequency reached) 22: Drive ready 23: Multi-pump system error display (only master) 24: Preheating function indication 25: Fire mode indication	8	
03.02	Desired Frequency Reached	0.00–400.0 Hz	0.00	
03.05	Terminal Count Value	0–9999	0	
03.06	Preliminary Count Value	0–9999	0	
03.07	EF Active when Terminal Count Value Reached	0: Terminal count value reached, no EF display 1: Terminal count value reached, EF active	0	
03.08	Fan Control	0: Fan is always ON 1: One minute after the AC motor drive stops, the fan is OFF. 2: Fan is ON when the AC motor drive runs, fan is OFF when the AC motor drive stops. 3: Fan is ON when the preliminary heat sink temperature is reached. 4: Fan is ON when the AC motor drive runs; fan is OFF when the AC motor drive stops. And the fan is in a standby mode at 0 Hz.	0	

Parameter	Function	Setting	Default	Customer
03.11	Mechanical Brake Release Frequency	0.00–20.00 Hz	0.00	
03.12	Mechanical Brake Engage Frequency	0.00–20.00 Hz	0.00	
03.13	Display the Status of the Multi-function Output Terminals	Read only	Read only	

Group 4 Input Function Parameters

Parameter	Function	Setting	Default	Customer
↗04.00	Keypad Potentiometer Bias	0.0–100.0%	0.0	
↗04.01	Keypad Potentiometer Bias Polarity	0: Positive bias 1: Negative bias	0	
↗04.02	Keypad Potentiometer Gain	0.1–200.0%	100.0	
04.03	Keypad Potentiometer Negative Bias, Reverse Motion Enable / Disable	0: No negative bias command 1: Negative bias: REV motion enabled	0	
04.04	Start-up / Stop Method of MI Terminals and Multi-function Input Selection	Mode 1 (Pr.04.19=0) 0: MI1 start-up (keypad FWD lights) / stop Mode 2 (Pr.04-19=1) 0: Two-wire (1) MI1, MI2 1: Two-wire (2) MI1, MI2 2: Three-wire, MI1, MI2, MI3	0	
04.05	Reserved	0: No function	-	
04.06	Start-up / Stop or Multi-function Input Terminal (MI2)	1: Multi-step speed command 1	1	
04.07	Start-up / Stop or Multi-function Input Terminal (MI3)	2: Multi-step speed command 2	2	
04.08	Multi-function Input Terminal (MI4)	3: Multi-step speed command 3	3	
		5: External reset 6: Accel. / decel. inhibit 7: The 1 st , 2 nd acceleration or deceleration time selection 8: JOG operation control 9: External Base Block (Refer to Pr.08.06) 10: UP: Increase Master Frequency 11: DOWN: Decrease Master Frequency 12: Counter trigger 13: Counter reset 14: External fault 15: PID function disabled 16: Output shutoff stop 17: Parameter lock enable 18: Operation command selection (Pr.02.01 setting / external terminals) 19: Operation command selection (Pr.02.01 setting / digital keypad) 20: Operation command selection (Pr.02.01 setting / communication) 21: Forward / reverse 22: Second frequency command source		

Parameter	Function	Setting	Default	Customer
		23: Simple positioning stop by forward limit 24: Simple positioning stop by reverse limit 25: Multi-pump control by Hand or Auto mode 26: Auto-trigger preheating function 27: Fire mode enabled (without Operation Command) 28: Fire mode enabled (with Operation Command)		
04.09	Multi-function Input Contact Selection	0–63	0	
04.10	Digital Terminal Input Response Time	1–20 (*2ms)	1	
↗04.11	Minimum AVI Voltage	0.0–10.0 V	0.0	
↗04.12	Minimum AVI Frequency (percentage of Pr.01.00)	0.0–100.0% [100% corresponds to Fmax (Pr.01.00)]	0.0	
↗04.13	Maximum AVI Voltage	0.0–10.0 V	10.0	
↗04.14	Maximum AVI Frequency (percentage of Pr.01.00)	0.00–100.00% [100% corresponds to Fmax (Pr.01.00)]	100.00	
↗04.15	Minimum ACI Current	0.0–20.0 mA	4.0	
↗04.16	Minimum ACI Frequency (percentage of Pr.01.00)	0.00–100.00% [100% corresponds to Fmax (Pr.01.00)]	0.0	
↗04.17	Maximum ACI Current	0.0–20.0 mA	20.0	
↗04.18	Maximum ACI Frequency (percentage of Pr.01.00)	0.00–100.00% [100% corresponds to Fmax (Pr.01.00)]	100.0	
04.19	MI Terminal Control Mode Selection	0: Mode 1 (MI1: Start-up/Stop terminal; MI2 & MI3: multi-function input terminals) 1: Mode 2 (MI1/MI2/MI3 support two-wire / three-wire start-up)	0	
04.26	Display the Status of Multi-function Input Terminal	Read only	Read only	
↗04.27	Internal/External Multi-function Input Terminals Selection	0–4095	0	
↗04.28	Internal Terminal Status	0–4095	0	
↗04.29	Delay Time of Multi-function Input Terminal (MI1) Turn On	0.00–360.00 sec.	0.00	
↗04.30	Delay Time of Multi-function Input Terminal (MI1) Turn Off	0.00–360.00 sec.	0.00	
↗04.31	Delay Time of Multi-function Input Terminal(MI2) Turn On	0.00–360.00 sec.	0.00	
↗04.32	Delay Time of Multi-function Input Terminal (MI2) Turn Off	0.00–360.00 sec.	0.00	
↗04.33	Delay Time of Multi-function Input Terminal (MI3) Turn On	0.00–360.00 sec.	0.00	

Parameter	Function	Setting	Default	Customer
↗04.34	Delay Time of Multi-function Input Terminal (MI3) Turn Off	0.00–360.00 sec.	0.00	

Group 5 Multi-Step Speed Parameters

Parameter	Function	Setting	Default	Customer
↗05.00	1st Step Speed Frequency	0.00–400.0 Hz	0.00	
↗05.01	2nd Step Speed Frequency	0.00–400.0 Hz	0.00	
↗05.02	3rd Step Speed Frequency	0.00–400.0 Hz	0.00	
↗05.03	4th Step Speed Frequency	0.00–400.0 Hz	0.00	
↗05.04	5th Step Speed Frequency	0.00–400.0 Hz	0.00	
↗05.05	6th Step Speed Frequency	0.00–400.0 Hz	0.00	
↗05.06	7th Step Speed Frequency	0.00–400.0 Hz	0.00	

Group 6 Protection Parameters

Parameter	Function	Setting	Default	Customer
06.00	Over-Voltage Stall Prevention	230V series: 330.0–410.0 V 460V series: 660.0–820.0 V	390.0 780.0	
↗06.01	Over-Current Stall Prevention during Acceleration	0:Disable 20–250%	170	
↗06.02	Over-Current Stall Prevention during Operation	0:Disable 20–250%	170	
06.03	Over-Torque Detection Mode (oL2)	0: Over-torque detection disabled 1: Over-torque detection enabled during constant speed operation. After over-torque is detected, keep running until oL1 or oL occurs. 2: Over-torque detection enabled during constant speed operation. After over-torque is detected, stop running. 3: Over-torque detection enabled during acceleration. After over-torque is detected, keep running until oL1 occurs. 4: Over-torque detection enabled during acceleration. After over-torque is detected, stop running.	0	
↗06.04	Over-Torque Detection Level	10–200%	150	
06.05	Over-Torque Detection Time	0.1–60.0 sec.	0.1	
06.06	Electronic Thermal Overload Relay Selection (oL1)	0: Standard motor (self-cooled by fan) 1: Special motor (forced external cooling) 2: Disabled	2	
06.07	Electronic Thermal Characteristic	30–600 sec.	60	
06.08	Present Fault Record	0: No fault	0	
06.09	Second Most Recent Fault Record	1: Over current (oc) 2: Over voltage (ov)		
06.10	Third Most Recent Fault Record	3: IGBT Overheat (oH1) 5: Overload (oL)		
06.11	Fourth Most Recent Fault Record	6: Overload1 (oL1) 7: Motor overload (oL2)		
06.12	Fifth Most Recent Fault Record	8: External fault (E.F.) 9: Current exceeds two times the rated current during acceleration (ocA)		
		10: Current exceeds two times the rated current during deceleration (ocd)		
		11: Current exceeds two times the rated current during constant speed operation (ocn)		
		14: Phase-Loss (PHL) 16: Auto-acceleration / auto-deceleration failure (CFA) 17: Software / Password protection (codE) 18: Power Board CPU WRITE failure (cF1.0) 19: Power Board CPU READ failure (cF2.0) 20: CC, OC Hardware protection failure (HPF1) 21: OV Hardware protection failure (HPF2)		

Parameter	Function	Setting	Default	Customer
		23: OC Hardware protection failure (HPF4) 24: U-phase error (cF3.0) 25: V-phase error (cF3.1) 26: W-phase error (cF3.2) 27: DC bus error (cF3.3) 28: IGBT Overheat error (cF3.4) 34: Motor PTC overheat protection (PtC1) 35: FBE_ERR: PID feedback error (Incorrect feedback signal) 36: dEv: unusual PID feedback deviation 37: OPHL		
↗06.13	Motor Disconnection Detection Time	0.0–60.0 0.0: Disable the OPHL detection function	0.0	
↗06.14	Motor Disconnection Detection Current Level	10–100	30	

Group 7 Motor Parameters

Parameter	Explanation	Settings	Default	Customer
↗07.00	Motor Rated Current	23–120% FLA	100	
↗07.01	Motor No-Load Current	0–99% FLA	40	
↗07.02	Torque Compensation	0.0–10.0	0.0	
↗07.03	Slip Compensation Gain	0.00–10.00	0.00	
↗07.04	Motor Parameter Auto-Tuning	0: Disable 1: Auto-tuning R1 (Motor does not run) 2: Auto-tuning R1 + No-load current (with running motor)	0	
07.05	Motor Line-to-line Resistance R1 (Motor 0)	0–65535 mΩ	0	
07.06	Motor Rated Slip (Motor 0)	0.00–20.00 Hz	3.00	
07.07	Slip Compensation Limit	0–250%	200	
07.08	Torque Compensation Time Constant	0.01–10.00 sec.	0.10	
07.09	Slip Compensation Time Constant	0.05–10.00 sec.	0.20	
07.10	Accumulated Motor Operation Time (Minute)	0–1439 Min.	0	
07.11	Accumulated Motor Operation Time (Day)	0–65535 Day	0	
07.12	Motor PTC Overheat Protection	0: Disable 1: Enable	0	
07.13	Motor PTC Protection Input Response Time	0–9999 (*2 ms)	100	
07.14	Motor PTC Overheat Protection Level	0.1–10.0 V	2.4	
07.15	Motor PTC Overheat Warning Level	0.1–10.0 V	1.2	
07.16	Motor PTC Overheat Reset Delta Level	0.1–5.0 V	0.6	
07.17	Motor PTC Overheat Action	0: Warn and ramp to stop 1: Warn and coast to stop 2: Warn and keep operating	0	

Group 8 Special Parameters

Parameter	Explanation	Settings	Default	Customer
08.00	DC Brake Current Level	0–100%	0	
08.01	DC Brake Time during Start-Up	0.0–60.0 sec.	0.0	
08.02	DC Brake Time during Stopping	0.0–60.0 sec.	0.0	
08.03	Start-point for DC Brake	0.00–400.0 Hz	0.00	
08.04	Momentary Power Loss Action	0: Operation stops (coast to stop) after momentary power loss 1: Operation continues after momentary power loss, speed search starts with the last frequency 2: Operation continues after momentary power loss, speed search starts with the minimum frequency	0	
08.05	Maximum Allowable Power Loss Time	0.1–20.0 sec.	2.0	
08.06	Base Block Speed Search	0: Disable 1: Speed search starts with the last frequency command 2: Speed search starts with the minimum output Frequency (Pr.01.05)	1	
08.07	Base Block Time for Speed Search (B.B.)	0.1–5.0 sec.	0.5	
08.08	Current Limit for Speed Search	30–200%	150	
↗08.09	Skip Frequency 1 Upper Limit	0.00–400.00 Hz	0.00	
↗08.10	Skip Frequency 1 Lower Limit	0.00–400.00 Hz	0.00	
↗08.11	Skip Frequency 2 Upper Limit	0.00–400.00 Hz	0.00	
↗08.12	Skip Frequency 2 Lower Limit	0.00–400.00 Hz	0.00	
↗08.13	Skip Frequency 3 Upper Limit	0.00–400.00 Hz	0.00	
↗08.14	Skip Frequency 3 Lower Limit	0.00–400.00 Hz	0.00	
08.15	Number of Auto-restarts after Fault	0–10	0	
08.16	Auto-reset Time for Restart after Fault	0.1–6000 sec.	60.0	
08.17	Auto-energy Saving	0: Disable Energy-saving operation 1: Enable Energy-saving operation	0	
08.18	Automatic Voltage Regulation (AVR)	0: AVR function enable 1: AVR function disable 2: AVR function disable for deceleration 3: AVR function disable for stop	0	
↗08.20	Compensation Coefficient for Motor Instability	0.0–5.0	0.0	
08.21	DC Current Level during Preheating	0–100%	0	
08.22	DC Current Cycle Time during Preheating	0–100%	0	
08.23	Fire mode	0 : No function 1 : Forward running 2 : Reverse in reverse	0	
08.24	Operating Frequency during Fire Mode	0.00–400.00 Hz	60.00	

Parameter	Explanation	Settings	Default	Customer
08.25	Number of Fire Mode Actions	Refer to parameter description	Read only	

Group 9 Communication Parameters

Parameter	Explanation	Settings	Default	Customer
↗09.00	Communication Address	1–254	1	
↗09.01	Transmission Speed	0: Baud rate 4800 bps (bits / second) 1: Baud rate 9600 bps (bits / second) 2: Baud rate 19200 bps (bits / second) 3: Baud rate 38400 bps (bits / second)	1	
↗09.02	Transmission Fault Action	0: Warn and keep operating 1: Warn and ramp to stop 2: Warn and coast to stop 3: No warning and keep operating	3	
↗09.03	Time-out Detection	0.0–120.0 sec. 0.0: Disable	0.0	
↗09.04	Communication Protocol	0: 7,N,2 (Modbus, ASCII) 1: 7,E,1 (Modbus, ASCII) 2: 7,O,1 (Modbus, ASCII) 3: 8,N,2 (Modbus, RTU) 4: 8,E,1 (Modbus, RTU) 5: 8,O,1 (Modbus, RTU) 6: 8,N,1 (Modbus, RTU) 7: 8,E,2 (Modbus, RTU) 8: 8,O,2 (Modbus, RTU) 9: 7,N,1 (Modbus, ASCII) 10: 7,E,2 (Modbus, ASCII) 11: 7,O,2 (Modbus, ASCII)	0	
↗09.07	Response Delay Time	0–200 (1 unit = 2 ms.)	1	

Group 10 PID Control Parameters

Parameter	Explanation	Settings	Default	Customer
10.00	PID Set Point Selection	0: Disable PID operation 1: Digital keypad UP/DOWN keys 2: Reserved 3: Reserved 4: PID set point (Pr.10.11)	0	
10.01	Input Terminal for PID Feedback	0: Positive PID feedback from external terminal AVI (0–10 V _{DC}) 1: Negative PID feedback from external terminal AVI (0–10 V _{DC}) 2: Positive PID feedback from external terminal ACI (4–20 mA) 3: Negative PID feedback from external terminal ACI (4–20 mA)	0	
✓ 10.02	Proportional Gain (P)	0.0–10.0	1.0	
✓ 10.03	Integral Time (I)	0.00–100.0 sec. (0.00=disable)	1.00	
✓ 10.04	Differential Time (D)	0.00–1.00 sec.	0.00	
10.05	Upper Bound for Integral Control	0–100%	100	
10.06	PID Filter Time	0.0–2.5 sec.	0.0	
10.07	PID Output Frequency Limit	0–110%	100	
10.08	PID Feedback Signal Detection Time	0.0–3600.0 sec.	60.0	
10.09	Erroneous PID Feedback Signal Action	0: Warn and ramp to stop 1: Warn and coast to stop 2: Warn and keep operation	0	
10.10	Gain Over the PID Detection Value	0.0–10.0	1.0	
✓ 10.11	PID Set Point Value	0.00–400.00 Hz (valid when Pr.10.00=4)	0.00	
10.12	PID Deviation Level	0.0–100.0%	10.0	
10.13	PID Deviation Detection Time	0.1–300.0 sec.	5.0	
10.14	Sleep Detection Time	0.0–6550 sec.	0.0	
10.15	Sleep Frequency	0.00 to Fmax Hz	0.00	
10.16	Wake-up Frequency	0.00 to Fmax Hz	0.00	
10.17	PID Offset	0.00–60.00 Hz	0.00	
10.18	Feedback of PID Physical Quantity Value	1.0–99.9	99.9	
10.19	PID Calculation Mode Selection	0: Serial mode 1: Parallel mode	0	

Parameter	Explanation	Settings	Default	Customer
10.20	Erroneous PID Feedback Deviation Level Action	0: Warn and keep operating 1: Warn and coast to stop 2: Warn and ramp to stop 3: Ramp to stop and restart after Pr.10.21 delay time (No display of error and warning) 4: Ramp to stop and restart after Pr.10.21 delay time. The number of times of restart is limited by Pr.10.50 (Number of Times of Restart after PID Fault).	0	
10.21	Restart Delay Time after Erroneous PID Deviation Level	0–9999 sec.	60	
↗10.22	Set Point Deviation Level	0–100%	0	
↗10.23	Detection Time of Set Point Deviation Level	0–9999 sec.	10	
↗10.24	Deviation Level of Liquid Leakage	0–50%	0	
↗10.25	Liquid Leakage Change Detection	0–100% (0: disable)	0	
↗10.26	Time Setting for Liquid Leakage Change	0.1–10.0 sec. (0: disable)	0.5	
10.35	Multi-Pump Control Mode	0: Disable 1: Fixed Time Circulation (alternative operation) 2: Fixed quantity control (multi-pump operating at constant pressure)	0	
10.36	Multi-pump ID	0: Multi-pump control mode is disabled 1: Master 2–4: Slave	0	
↗10.37	Multi-pump's Fixed Time Circulation Period	1–65535 (minute)	60	
↗10.38	Frequency to Start Switching Pumps	0.00 Hz–Fmax	60.00	
↗10.39	Time Detected When Pump Reaches the Starting Frequency	0.0–3600.0 sec.	1	
↗10.40	Frequency to Stop Switching Pumps	0.00 Hz–Fmax	48.00	
↗10.41	Time Detected When Pump Reaches the Stopping Frequency	0.0–3600.0 (sec.)	1.0	
↗10.42	Pump's Frequency at Time-out (Disconnection)	0.00 Hz–Fmax	0.00	
10.43	Pump's Error Treatment	bit0: Determines whether the erroneous pump switches to an alternative pump when an error occurs in the running pump 0: All pumps stop 1: Switch to an alternative pump	1	

Parameter	Explanation	Settings	Default	Customer
		bit1: Determines the erroneous pump to be in a standby or stop status after reset 0: Set the erroneous pump to be in a standby status after reset 1: Set the erroneous pump to be in a stop status after reset bit2: Determines whether the master pump received the RUN command or not when an error occurs in the running pump 0: When an error occurs in the running pump, the master pump does not receive the RUN command 1: When an error occurs in the running pump, the master pump can choose to run with an alternative pump, instead of the erroneous pump		
10.44	Selection of Pump's Start-up Sequence	0: By pump ID # 1: By running time.	1	
↗ 10.45	Running Time of Multi-pump Under Alternative Operation	0.0–360.0 sec.	60.0	
↗ 10.49	Specify the Setting for Pr. 10.12 [PID Deviation Level]	0: Use the existing setting (default), and check for any error per the feedback deviation 1: Set the low water pressure percentage (%), and check for any error per the physical quantity feedback.	0	
↗ 10.50	Number of Times of Restart after PID Fault	0–1000 times	0	

4.2 Parameter Settings for Applications

Speed Search

Applications	Purpose	Functions	Related Parameters
Windmills, winding machines, fans and all inertia loads	Restart a free-running motor	Before the free-running motor stops completely, the AC motor drive auto-searches the motor speed and accelerates when its speed is the same as the motor speed.	08.04–08.08

DC Brake before Running

Applications	Purpose	Functions	Related Parameters
Windmills, fans, pumps and others rotate freely without power due to wind or flow	Keep the free-running motor at standstill	If the running direction of the free-running motor is not steady, execute DC brake before start-up.	08.00, 08.01

Energy Saving

Applications	Purpose	Functions	Related Parameters
Punching machines, fans, pumps and precision machinery	Save energy and reduce vibration	Save energy when the AC motor drive runs at constant speed, yet has full power acceleration and deceleration. For precision machinery, it also helps reduce vibration.	08.17

Eight-step Speed Operation

Applications	Purpose	Functions	Related Parameters
Conveying machinery	Cyclic operation at multi-step speed	To control eight-step speed (including master frequency) and duration by simple contact signals.	04.06–04.08 05.00–05.06

Switching Acceleration and Deceleration Time

Applications	Purpose	Functions	Related Parameters
Auto-turnstile for conveying machinery	Switch acceleration and deceleration time through external signal	When an AC motor drive drives two or more motors, it can reach a high-speed but still start and stop smoothly.	01.09–01.12 04.06–04.08

Overheating Warning

Applications	Purpose	Functions	Related Parameters
Air conditioners	Safety measure	When an AC motor drive overheats, a thermal sensor triggers the overheating warning.	03.00, 04.06–04.08

Operation Command

Applications	Purpose	Functions	Related Parameters
General application	Select the control signal source	Select the AC motor drive control by external terminals or digital keypad or RS-485.	02.01, 04.06–04.08

Frequency Hold

Applications	Purpose	Functions	Related Parameters
General application	Acceleration / deceleration pause	Hold output frequency during acceleration / deceleration	04.06–04.08

Auto-restart after Fault

Applications	Purpose	Functions	Related Parameters
Air conditioners, remote pumps	For continuous and reliable operation	The AC motor drive can automatically restart / reset up to 10 times after a fault occurs.	08.15, 08.16

Emergency Stop by DC Brake

Applications	Purpose	Functions	Related Parameters
High-speed rotors	Emergency stop without brake resistor	The AC motor drive can use the DC brake for emergency stop when a quick stop is needed without a brake resistor. Take motor cooling into consideration when using DC braking often.	08.00–08.03

Over-torque Setting

Applications	Purpose	Functions	Related Parameters
Pumps, fans and extruders	To protect machines and for continuous / reliable operation	Set the over-torque detection level. When OC stall, OV stall or over-torque occurs, the drive automatically adjusts the output frequency. It is suitable for machines like fans and pumps that require continuous operation.	06.00–06.05

Upper / Lower Limit Frequency

Applications	Purpose	Functions	Related Parameters
Pumps and fans	Control the motor speed within upper / lower limit	When you cannot provide the upper / lower limit, gain or bias from external signals, you can set the limits in the AC motor drive.	01.07 01.08

Skip Frequency Setting

Applications	Purpose	Functions	Related Parameters
Pumps and fans	To prevent machine resonance vibration	The AC motor drive does not run at constant speed in the skip frequency range. You can set up to three skip frequency ranges.	08.09–08.14

Carrier Frequency Setting

Applications	Purpose	Functions	Related Parameters
General application	Reduce noise	Increase the carrier frequency to reduce motor noise.	02.03

Keep Running when Frequency Command is Lost

Applications	Purpose	Functions	Related Parameters
Air conditioners	For continuous operation	When the frequency command is lost because of a system malfunction, the AC motor drive still runs. Suitable for intelligent air conditioners.	02.06

Output Signal during Running

Applications	Purpose	Functions	Related Parameters
General application; mechanical brake	Provide a signal for running status	Signal available to stop braking (brake release) when the AC motor drive is running. (This signal disappears when the AC motor drive is free-running.)	03.00

Output Signal in Zero Speed

Applications	Purpose	Functions	Related Parameters
General application; machine tools	Provide a signal for running status	When the drive's output frequency is lower than the minimum output frequency, gives a signal for an external system or control wiring.	03.00

Output Signal at Set Frequency

Applications	Purpose	Functions	Related Parameters
General application; machine tools	Provide a signal for running status	When the drive's output frequency reaches the set frequency (from the frequency command), gives a signal for an external system or control wiring (frequency reached).	03.00

Output Signal at Over-torque

Applications	Purpose	Functions	Related Parameters
Machine tools, fans, pumps, and extruders	To protect machines and for reliable operation	When the motor over-torque is larger than the drive's setting level, gives a signal to prevent the machine from damage due to load.	03.00, 06.04–06.05

Output Signal at Low Voltage

Applications	Purpose	Functions	Related Parameters
General application	Provide a signal for running status	When low voltage is detected after the motor detects the P-N voltages, gives a signal for an external system or control wiring.	03.00

Output Signal at Desired Frequency

Applications	Purpose	Functions	Related Parameters
General application	Provide a signal for running status	When the drive's output frequency reaches the desired frequency, gives a signal for an external system or control wiring.	03.00–03.02

Output Signal for Base Block

Applications	Purpose	Functions	Related Parameters
General application	Provide a signal for running status	When executing a Base Block, gives a signal for an external system or control wiring.	03.00

Overheating Warning for Heat Sink

Applications	Purpose	Functions	Related Parameters
General application	For safety	When the heat sink overheats, gives a signal for an external system or control wiring.	03.00

4.3 Description of Parameter Settings

Group 0: User Parameters

✎ You can set this parameter during operation.

00.00	AC Motor Drive Identity Code				
	Settings	Read Only			Default: ##
00.01	AC Motor Drive Rated Current Display				
	Settings	Read Only			Default: ##

📖 Pr. 00.00 displays the AC motor drive identity code. The identity code includes the capacity, rated current, rated voltage and the maximum carrier frequency. The following table explains the identity code.

📖 Pr.00.01 displays the rated current of the AC motor drive. You can use it to check if the AC motor drive is correct.

230V Series					
kW	0.2	0.4	0.75	1.5	2.2
HP	0.25	0.5	1.0	2.0	3.0
Pr.00.00	0	2	4	6	8
Rated Output Current (A)	1.6	2.5	4.2	7.5	11.0
Max. Carrier Frequency	12 kHz				

460V Series					
kW	0.4	0.75	1.5	2.2	4.0
HP	0.5	1.0	2.0	3.0	5.5
Pr.00.00	3	5	7	9	11
Rated Output Current (A)	1.5	2.5	4.2	5.5	9.0
Max. Carrier Frequency	12 kHz				

00.02	Parameter Reset				
					Default: 0
Settings	0	Parameter can be read/written			
	1	All parameters are read-only			
	8	Keypad lock			
	9	Reset all parameters to defaults (50Hz, 230V/400V or 220V/380V depending on Pr.00.12)			
	10	Reset all parameters to defaults (60Hz,-220V/440V)			

📖 9 or 10: Resets all parameters to defaults when the parameter settings are abnormal.

📖 9: Resets all parameters to defaults for 50 Hz; the base voltage depends on the Pr.00.12 settings.













📖 1: All parameters are read-only and you cannot change any parameter settings. Err displays when you enter any input. To write all parameters, set Pr.00.02 = 0.

00.03	✎ Start-up Display Selection				
					Default: 0
Settings	0	Display the frequency command value (F)			
	1	Display the actual output frequency (H)			
	2	Display the output current in Amps supplied to the motor (A)			
	3	Display the content of the user-defined unit (U)			
	4	FWD/REV command			

📖 Determines the start-up display page after power is applied to the drive.

00.04 Content of Multi-function Display

Default: 0

Settings	0	Display the content of the user-defined unit (U)	
	1	Display the counter value that counts the number of pulses on TRG terminal (c)	
	2	Display status of multi-function input terminals	
	3	Display the actual DC bus voltage in V _{DC} for the AC motor drive	
	4	Display the output voltage in V _{AC} for terminals U/T1, V/T2, W/T3 to the motor. (E)	
	5	Display the PID analog feedback signal value in % (b)	
	6	Display the power factor angle in ° for terminals U/T1, V/T2, W/T3 to the motor (n)	
	7	Display the output power in kW for terminals U, V and W to the motor. (P)	
	8	Display the setting values for PID control and feedback signal.	
	9	Display the signal of the AVI analog input terminal (V).	
	10	Display the signal of the ACI analog input terminal that corresponds to 0–100% (mA/V) (i).	
	11	Display the temperature of the IGBT in °C (h)	

 When you set Pr.00.03 to 3, the display is according to Pr.00.04.

00.05 User-defined Coefficient K

Unit: 0.1

Settings 0.1–160.0

Default: 1.0

 Determines the multiplying factor (K) for the user-defined unit.

The display value is calculated as follows:

User-defined unit (U) = Output frequency (H) * User-defined Coefficient (K) (Pr.00.05)

00.06 Software Version

Settings Read Only

Default: #.##

00.07 Reserved**00.08** Password Input

Unit: 1

Settings 0–9999

Default: 0

 Displayed value 0–2 is the number of wrong password attempts.

 Enter the password that is set in Pr.00.09. Enter the correct password here to enable changing parameter settings. You are limited to a maximum of three attempts. After three consecutive failed attempts, a blinking “codE” appears. You must restart the AC motor drive before you can try again to enter the correct password.

00.09 Set Password

Unit: 1

Settings 0–9999

Default: 0

 Sets a password to protect your parameter settings.

If the display shows 0, no password is set or the password is correctly set in Pr.00.08. You can then change all parameters, including Pr.00.09.

The first time you can set a password directly. After successfully setting the password, the display shows 1.

Be sure to record the password for later use.

To cancel the parameter lock, set Pr.00.09 to 0 after entering the correct password in Pr.00.08.

The password consists of between 1–4 digits.

 You can re-enable the password after decoding with Pr.00.08:

Method 1: Enter the original password in Pr.00.09 again (or you can enter a new password; be sure to record it).

Method 2: Restart the drive to re-enable the password function.

Method 3: Enter any value that is not the password in Pr.00.08. (Pr.00.08 displays End regardless of whether the password is entered correctly.)

Password Decode Flow Chart

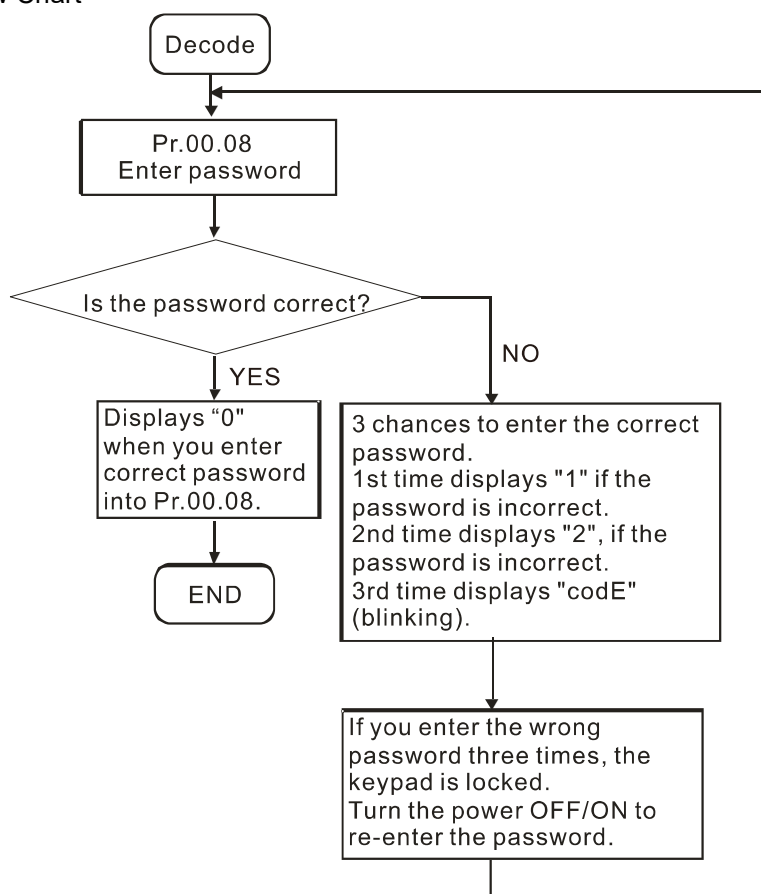

00.10 Control Mode

Default: 0

Display	0	V/F Control
	1	Vector Control

Determines the control method for the AC motor drive.

V/F Control: (Voltage/Frequency Control)

The V/F control is a constant value control mode. In this control mode, frequency decreasing and magnetic field increasing are under control. But as the frequency decreases, a problem rises: the insufficiency of motor's torque in a weakened low frequency magnetic field. To solve this problem, set Pr.07.02 Torque Compensation to compensate torque then to have the best operating performance. Common applications are water pumps, conveyors, compressors and treadmills.

Vector Control:

The vector control mode can eliminate the relationship between the field current vector and the armature flux, and auto-tune the torque compensation and slip compensation to increase the dynamic response of the motor drive. Common applications are textile equipment, printing equipment, crane equipment and drilling machinery.

Related parameter: Pr.07.02 Torque Compensation.

00.11 Reserved

00.12 50 Hz Base Voltage Selection

Default: 0

Settings	0	230V/400V
	1	220V/380V



Determines the base voltage for 50 Hz.

00.13 User-defined Value (corresponds to maximum operating frequency Pr.01.00)

Settings

0–9999

Default: 0



-  When Pr.00.13 is not set to 0, “F” automatically disappears in frequency mode and the rightmost digit blinks. The ranges for many functions display according to Pr.00.13, including the UP/DOWN key on keypad potentiometer, multi-step speed function, and JOG function.
-  When Pr.00.13 is not set to 0, and the frequency source is from communications, use Pr.02.18 to change the frequency command instead of using communication address 2001H.

00.14 Decimal Place of User-defined Value

Settings

0–3

Default: 0

-  Sets the place of decimal point for Pr.00.13.
-  Example: If you want to set the user-defined value to 10.0, set Pr.00.13 to 100 and Pr.00.14 to 1.

Group 1: Basic Parameters

✎ You can set this parameter during operation.

01.00	Maximum Output Frequency (Fmax)	Unit: 0.01
Settings	50.00–400.0 Hz	Default: 60.00

 Determines the AC motor drive's Maximum Output Frequency. All the AC motor drive frequency command sources (analog inputs 0–10 V and 4–20 mA) are scaled to correspond to the output frequency range.

01.01	Motor Rated Frequency (Fbase)	Unit: 0.01
Settings	0.10–400.0 Hz	Default: 60.00

 Set this value according to the rated motor frequency as indicated on the motor nameplate. The Maximum Voltage Frequency determines the V/F curve ratio. For example, if the drive is rated for 460 V_{AC} output and you set the maximum voltage frequency to 60 Hz, the drive maintains a constant ratio of 7.66 V/Hz (460 V / 60 Hz = 7.66 V/Hz). This parameter value must be equal to or greater than the Mid-Point Frequency (Pr.01.03).

01.02	Motor Rated Voltage (Vbase)	Unit: 0.1
Settings	230V series 0.1–255.0 V	Default: 220.0
	460V series 0.1–510.0 V	Default: 440.0

 For 230V series, the default is 220.0 V; for 460V series, the default is 440.0 V.

 Sets the maximum output voltage. The setting must be smaller than or equal to the rated motor voltage as indicated on the motor nameplate.

01.03	Mid-Point Frequency (Fmid)	Unit: 0.01
Settings	0.10–400.0Hz	Default: 1.50

 Sets the Mid-Point Frequency of any V/F curve. This setting determines the V/F ratio between the Minimum Frequency and the Mid-Point frequency.

01.04	Mid-Point Voltage (Vmid)	Unit: 0.1
Settings	230V series 0.1–255.0 V	Default: 10.0
	460V series 0.1–510.0 V	Default: 20.0

 For 230V series, the default is 10.0 V; for 460V series, the default is 20.0 V.

 Sets the Mid-Point Voltage of any V/F curve. This setting determines the V/F ratio between the Minimum Frequency and the Mid-Point Frequency.

01.05	Minimum Output Frequency (Fmin)	Unit: 0.01
Settings	0.10–400.00 Hz	Default: 1.50

 Sets the Minimum Output Frequency of the AC motor drive. This parameter must be equal to or less than the Mid-Point Frequency (Pr.01.03).

01.06	Minimum Output Voltage (Vmin)	Unit: 0.1
Settings	230V series 0.1–255.0 V	Default: 10.0
	460V series 0.1–510.0 V	Default: 20.0

 For 230V series, the default is 10.0 V; for 460V series, the default is 20.0 V.

 Sets the Minimum Output Voltage of the AC motor drive. This parameter must be equal to or less than the Mid-Point Voltage (Pr.01.04).

 The settings for Pr.01.01–Pr.01.06 must meet the condition of $Pr.01.02 \geq Pr.01.04 \geq Pr.01.06$ and $Pr.01.01 \geq Pr.01.03 \geq Pr.01.05$.

01.07	Output Frequency Upper Limit	Unit: 0.1
Settings	0.1–120.0%	Default: 110.0

 This parameter must be equal to or greater than the Output Frequency Lower Limit (Pr.01.08). The Maximum Output Frequency (Pr.01.00) is equal to 100%.

 The Output Frequency Upper Limit value = $(Pr.01.00 * Pr.01.07) / 100$.

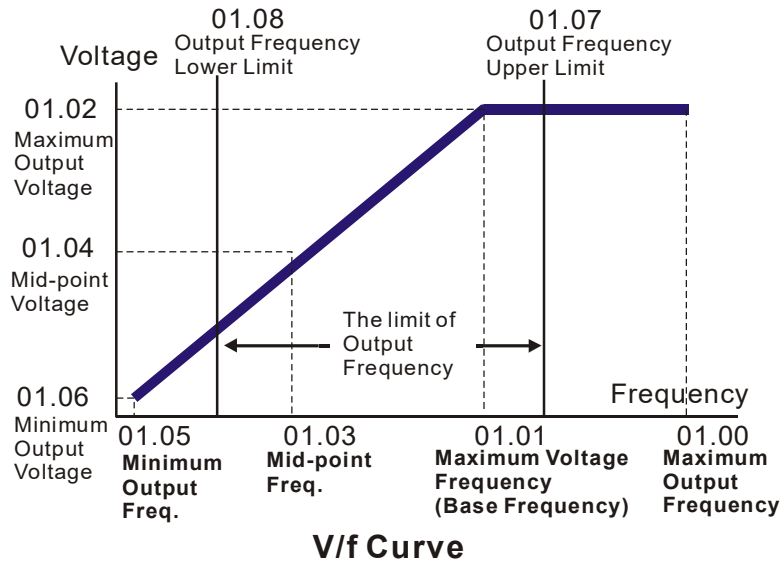

01.08	Output Frequency Lower Limit	Unit: 0.1
	Settings 0.0–100.0%	Default: 0.0

- The Output Frequency Lower Limit value = $(Pr.01.00 * Pr.01.08) / 100$.
- The Upper / Lower Limits are to prevent operation faults and machine damage.
- If the Output Frequency Upper Limit is 50 Hz and the Maximum Output Frequency (Pr.01.00) is 60 Hz, the Output Frequency will be limited to 50 Hz.
- If the Output Frequency Lower Limit is 10 Hz, and the Minimum Output Frequency (Pr.01.05) is 1.0 Hz, then any command frequency between 1.0–10 Hz generates a 10 Hz output from the drive. If the command frequency is less than 1.0 Hz, the drive is in ready status without output.
- If the Output Frequency Upper Limit is 60 Hz and the Maximum Output Frequency (Pr.01.00) is 60 Hz, the maximum output frequency will not be larger than 60 Hz even executing slip compensation. If the output frequency must be larger than 60 Hz, adjust the output frequency upper limit or increase the maximum operation frequency.

01.09	Acceleration Time 1 (Taccel 1)	Unit: 0.1/0.01
01.10	Deceleration Time 1 (Tdecel 1)	Unit: 0.1/0.01
01.11	Acceleration Time 2 (Taccel 2)	Unit: 0.1/0.01
01.12	Deceleration Time 2 (Tdecel 2)	Unit: 0.1/0.01
	Settings 0.1–600.0 sec. / 0.01–600.00 sec.	Default: 10.0

You can switch the acceleration/deceleration time 1 or 2 by setting the external terminals MI2–MI4 to 7.

01.19	Acceleration / Deceleration Time Unit	Default: 0
	Settings 0 Unit: 0.1 sec.	
	1 Unit: 0.01 sec.	

- Use the Acceleration Time to determine the time required for the AC motor drive to ramp from 0.0 Hz to Maximum Output Frequency (Pr.01.00). Use the Deceleration Time to determine the time required for the AC motor drive to decelerate from the Maximum Output Frequency (Pr.01.00) down to 0 Hz.
- You select the Acceleration/Deceleration Time 1, 2 with the Multi-function Input Terminals Settings. The defaults are Acceleration Time 1 / Deceleration Time 1.
- The setting for Pr.01.19 changes the time unit of Pr.01.09–Pr.01.12, Pr.01.13, and Pr.01.14, further changing the setting range of the acceleration / deceleration time.

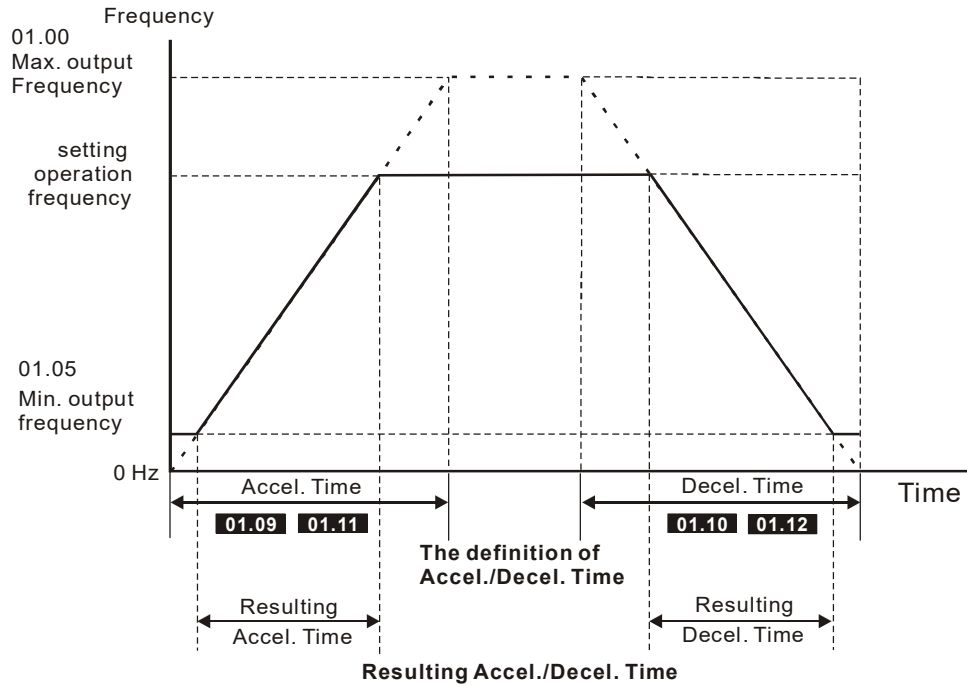

01.13	↗ Jog Acceleration Time	Unit: 0.1/0.01
	Settings 0.1–600.0/0.01–600.0 sec.	Default: 1.0
01.14	↘ Jog Deceleration Time	Unit: 0.1/0.01
	Settings 0.1 to 600.0/0.01 to 600.0 sec.	Default: 1.0
01.15	↗ Jog Frequency	Unit: 0.01
	Settings 0.10 to 400.0 Hz	Default: 6.00

- 📖 Use only external terminal JOG (setting MI2, MI3 or MI4 to 8). When the Jog command is ON, the AC motor drive accelerates from the Minimum Output Frequency (Pr.01.05) to the Jog Frequency (Pr.01.15). When the Jog command is OFF, the AC motor drive decelerates from the Jog Frequency to zero. The acceleration/deceleration time is set by the Jog Acceleration/Deceleration time (Pr.01.13, Pr.01.14).
- 📖 The drive must be stopped before using the JOG command. During Jog operation, other operation commands are not accepted, except FORWARD/REVERSE commands.

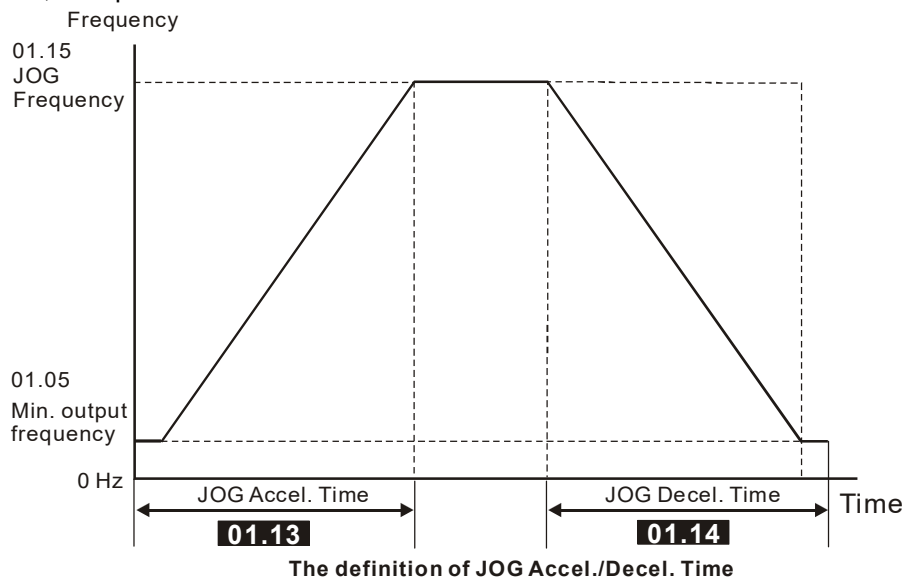

01.16	Auto-Acceleration and Auto-Deceleration		Default: 0
	Settings	0 Linear acceleration and linear deceleration	
		1 Auto-acceleration and linear deceleration.	

- 2 Linear acceleration and auto-deceleration.
- 3 Auto-acceleration and auto-deceleration (set by load)
- 4 Auto-acceleration and auto-deceleration (set by Acceleration/Deceleration Time setting)

- With auto-acceleration and auto-deceleration it is possible to reduce vibration and shocks during starting and stopping the load.

During auto-acceleration, the torque is automatically measured and the drive accelerates to the set frequency with the shortest acceleration time and the smoothest starting current.

During auto-deceleration, the drive measures the regenerative energy and the motor is stopped smoothly with the shortest deceleration time.

When this parameter is set to 4, the actual acceleration/deceleration time are equal to or greater than Pr.01.09–Pr.01.12.
- Auto-acceleration and auto-deceleration makes the complicated processes of tuning unnecessary. It makes operation efficient and saves energy by acceleration without stalling and deceleration without using the brake resistor.
- In applications with the brake resistor or brake unit, it is not recommended to use auto-deceleration.

01.17	Acceleration S-Curve	Unit: 0.1 / 0.01
01.18	Deceleration S-Curve	Unit: 0.1 / 0.01

Default: 0.0 / 0.00

Settings	0.0	S-curve disabled
	0.1–10.0/0.01–10.00	S-curve enabled (10.0/10.00 is the smoothest)

- Ensure smooth acceleration and deceleration using an S-curve.

0: Disables the S-curve function.

0.1–10.0/0.01–10.00: Enables the S-curve function.

Setting the parameter to 0.1/0.01 gives the shortest S-curve and setting the parameter to 10.0/10.00 gives the longest and smoothest S-curve.
- The following diagram shows that the original setting of the Acceleration and Deceleration Time is only for reference when you enable the S-curve. The actual acceleration and deceleration time depends on the selected S-curve (0.1 to 10.0). Pr.01.17 must be smaller than Pr.01.09 or Pr.01.11; Pr.01.18 must be smaller than Pr.01.10 or Pr.01.12. Otherwise, the S-curve is invalid.

The total acceleration time = Pr.01.09 + Pr.01.17 or Pr.01.11 + Pr.01.17

The total deceleration time = Pr.01.10 + Pr.01.18 or Pr.01.12 + Pr.01.18

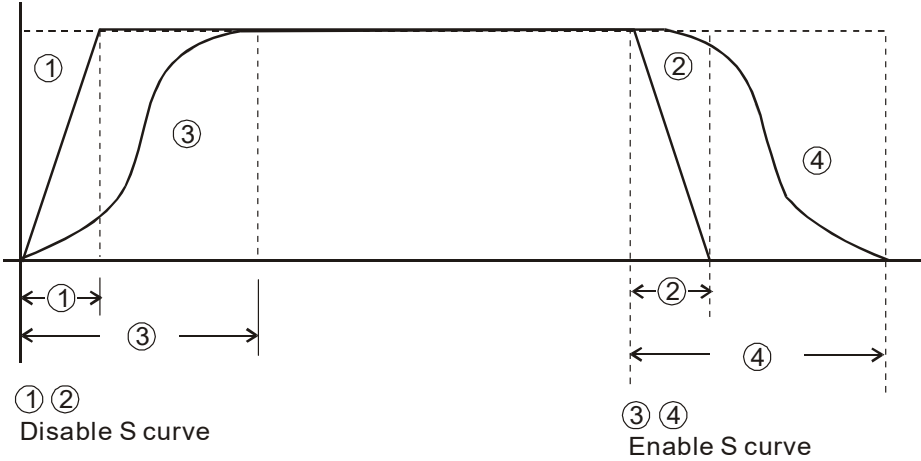



Acceleration/deceleration Characteristics

01.20	Simple Positioning Stop Frequency 0	Unit: 0.01
Settings	0.00–400.00Hz	Default: 0.00
01.21	Simple Positioning Stop Frequency 1	Unit: 0.01
Settings	0.00–400.00Hz	Default: 5.00
01.22	Simple Positioning Stop Frequency 2	Unit: 0.01
Settings	0.00–400.00Hz	Default: 10.00

01.23	↗ Simple Positioning Stop Frequency 3	Unit: 0.01
	Settings 0.00–400.00Hz	Default: 20.00
01.24	↗ Simple Positioning Stop Frequency 4	Unit: 0.01
	Settings 0.00–400.00Hz	Default: 30.00
01.25	↗ Simple Positioning Stop Frequency 5	Unit: 0.01
	Settings 0.00–400.00Hz	Default: 40.00
01.26	↗ Simple Positioning Stop Frequency 6	Unit: 0.01
	Settings 0.00–400.00 Hz	Default: 50.00
01.27	↗ Simple Positioning Stop Frequency 7	Unit: 0.01
	Settings 0.00–400.00 Hz	Default: 60.00

 The setting for Pr.01.20–Pr.01.27 must follow the condition below:

 $Pr.01.20 \leq Pr.01.21 \leq Pr.01.22 \leq Pr.01.23 \leq Pr.01.24 \leq Pr.01.25 \leq Pr.01.26 \leq Pr.01.27$

 If any two of the parameters (between Pr.01.20–Pr.01.27) have the same stop frequency, set their Delay Time of Simple Positioning Stop to the same values.

01.28	↗ Delay Time of Simple Positioning Stop 0	Unit: 0.01
	Settings 0.00–600.00 sec.	Default: 0.00
01.29	↗ Delay Time of Simple Positioning Stop 1	Unit: 0.01
	Settings 0.00–600.00 sec.	Default: 0.00
01.30	↗ Delay Time of Simple Positioning Stop 2	Unit: 0.01
	Settings 0.00–600.00 sec.	Default: 0.00
01.31	↗ Delay Time of Simple Positioning Stop 3	Unit: 0.01
	Settings 0.00–600.00 sec.	Default: 0.00
01.32	↗ Delay Time of Simple Positioning Stop 4	Unit: 0.01
	Settings 0.00–600.00 sec.	Default: 0.00
01.33	↗ Delay Time of Simple Positioning Stop 5	Unit: 0.01
	Settings 0.00–600.00 sec.	Default: 0.00
01.34	↗ Delay Time of Simple Positioning Stop 6	Unit: 0.01
	Settings 0.00–600.00 sec.	Default: 0.00
01.35	↗ Delay Time of Simple Positioning Stop 7	Unit: 0.01
	Settings 0.00–600.00 sec.	Default: 0.00

 This is valid only when Pr.02.02 motor stop method is set to 4: simple positioning stop.

 The settings 0–7 for Pr.01.20–Pr.01.27 must work with the settings 0–7 for Pr.01.28–Pr.01.35 and correspond to each other. Below is their corresponding.

(Pr.01.20, Pr.01.28)
(Pr.01.21, Pr.01.29)
(Pr.01.22, Pr.01.30)
(Pr.01.23, Pr.01.31)
(Pr.01.24, Pr.01.32)
(Pr.01.25, Pr.01.33)
(Pr.01.26, Pr.01.34)
(Pr.01.27, Pr.01.35)

 The function of Pr.01.28–Pr.01.35 is simple positioning. Speed starts to decelerate after the time set at Pr.01.28–Pr.01.35 elapses. The accuracy of positioning is self-assessed by user.

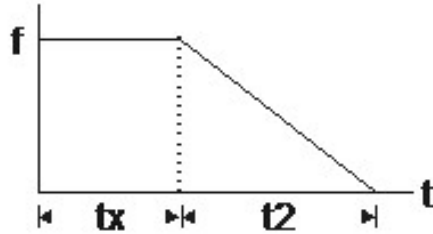

$$S = n \times \left(\frac{t_x + (t_x + t_2)}{2} \right)$$

s: operation distance (revolution)
 n: rotation speed (revolution/second)
 t_x : delay time (second)
 t_2 : deceleration time (second)

$$n = f \times \frac{120}{p}$$

n: rotation speed (revolution/ minute)
 p: number of poles in the motor
 f: operation frequency (Hz)

The value of t_x in the equation above describes as below.

When the slope is negative ($t_1 > t_2$)

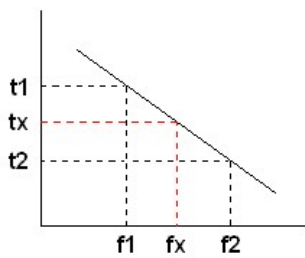

$$t_x = t_1 + \left(\frac{f_x - f_1}{f_2 - f_1} \right) \times (t_2 - t_1) = t_1 + \left(\frac{f_x - f_1}{10} \right) \times (t_2 - t_1)$$

When the slope is positive ($t_1 < t_2$)

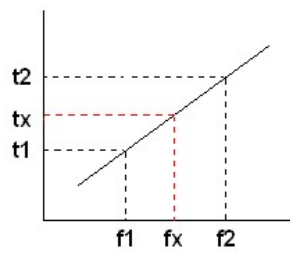

$$t_x = t_2 - \left(\frac{f_2 - f_x}{f_2 - f_1} \right) \times (t_2 - t_1) = t_2 - \left(\frac{f_2 - f_x}{10} \right) \times (t_2 - t_1)$$

As shown in the figure below, assume that the radius of the four-pole motor is r and rotation speed is n (RPM).

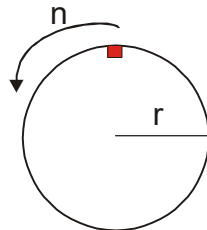

Example 1

When the motor swivel table rotates at 50 Hz, and Pr.02.02 = 4 [Simple Positioning Stop; E.F.: coast to stop], and Pr.01.26 = 50 Hz [Simple Positioning Stop Frequency 6], and its corresponding Pr.01.34 = 2 sec. [Delay Time of Simple Positioning Stop 6], then the deceleration time from 50 Hz to 0 Hz is 10 seconds.

After executing the stop command, Simple Positioning Stop activates, its rotation speed is

$$n = 120 \times 50 / 4 \text{ (revolution / minute)} = 25 \text{ (revolution / second)}$$

$$\text{The number of revolution of the swivel table} = (25 \times (2 + 12)) / 2 = 175 \text{ (revolutions)}$$

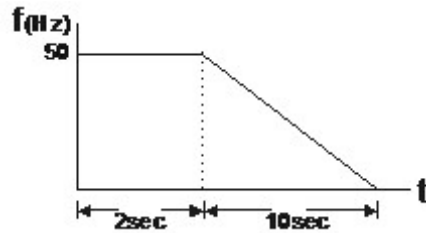

Therefore, the motor's operation distance after executing the stop command = number of revolutions \times circumference = $175 \times 2 \pi r$. It also means that the swivel table goes back to the top after 175 revolutions.

Example 2

Assume that the motor swivel table rotates at 1.5 Hz, and Pr.01.22 = 10 Hz [Simple Positioning Stop Frequency 2], and Pr.01.30 = 10 sec. [Delay Time of Simple Positioning Stop 2], then the deceleration time from 60 Hz to 0 Hz is 40 seconds.

The delay time at stop for 1.5 Hz is 1.5 second; the deceleration time from 1.5 Hz to 0 Hz is 1 second.

After executing the stop command, Simple Positioning Stop activates, its rotation speed is $n = 120 \times 1.5 / 4$ (revolution / minute) = $1.5 / 2$ (revolution / second)

The number of revolution of the swivel table = $(1.5 / 2 \times (1.5 + 2.5)) / 2 = 1.5$ (revolutions)

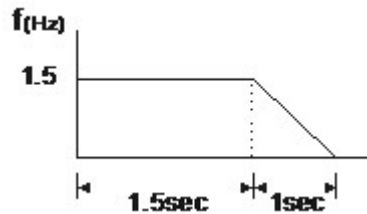

Therefore, the motor's operation distance after executing the stop command = number of revolutions \times circumference = $1.5 \times 2 \pi r$. It also means the swivel table stops after running 1.5 revolutions.

Group 2: Operation Method Parameters

✎ You can set this parameter during operation.

02.00 ✎ First Master Frequency Command Source

Default: 0

02.09 ✎ Second Master Frequency Command Source

Default: 0

Settings	0: Digital keypad UP/DOWN keys or Multi-function Inputs UP/DOWN.
	1: 0–10 V from AVI
	2: 4–20 mA from ACI
	3: RS-485 (RJ45) communication
	4: Digital keypad potentiometer

 Sets the Master Frequency Command Source for the AC motor drive.

 Pr.02.09 is only valid when you set one of Pr.04.06, Pr.04.07, or Pr.04.08 = 22. When setting 22 is activated, the frequency command source is the setting for Pr.02.09. You can only enable only one of the first master frequency command and second master frequency command sources at one time.

 When using the AVI terminal, pay attention to the ACI / AVI dip switch location on the AC motor drive. If you select ACI, the drive receives 4–20 mA analog current signal; if you select AVI, the drive receives 0–10 V_{DC} analog voltage signal.

02.01 ✎ First Operation Command Source

Default: 0

Settings	0: Digital keypad
	1: External terminals. Keypad STOP/RESET enabled.
	2: External terminals. Keypad STOP/RESET disabled.
	3: RS-485 communication. Keypad STOP/RESET enabled.
	4: RS-485 communication. Keypad STOP/RESET disabled.

 Sets the operation command source of the drive.

02.10 ✎ Combining the First and Second Master Frequency Commands

Default: 0

Settings	0: First Master Frequency Command Only
	1: First Master Frequency + Second Master Frequency
	2: First Master Frequency - Second Master Frequency

02.02 Stop Method

Default: 0

Settings	0: STOP: ramp to stop	E.F.: coast to stop
	1: STOP: coast to stop	E.F.: coast to stop
	2: STOP: ramp to stop	E.F.: ramp to stop
	3: STOP: coast to stop	E.F.: ramp to stop
	4: Simple positioning stop	E.F.: coast to stop

 This parameter determines how the motor is stopped when the AC motor drive receives a valid stop command or detects an external fault.

Ramp to stop: The AC motor drive decelerates to the Minimum Output Frequency (Pr.01.05) according to the deceleration time and then stops.

Coast to stop: The AC motor drive stops the output instantly and the motor coasts until it comes to a standstill.

 The motor stop method is usually determined by the characteristics of the motor load and how frequently it is stopped.

(1) It is recommended that you use “ramp to stop” for the safety of personnel or to prevent material from being wasted in applications where the motor has to stop after the drive is stopped. Set the deceleration time accordingly.

(2) If motor coasting is allowed or the load inertia is large, it is recommended that you use “coast to stop”.

Example uses are blowers, punching machines, centrifuges and pumps.

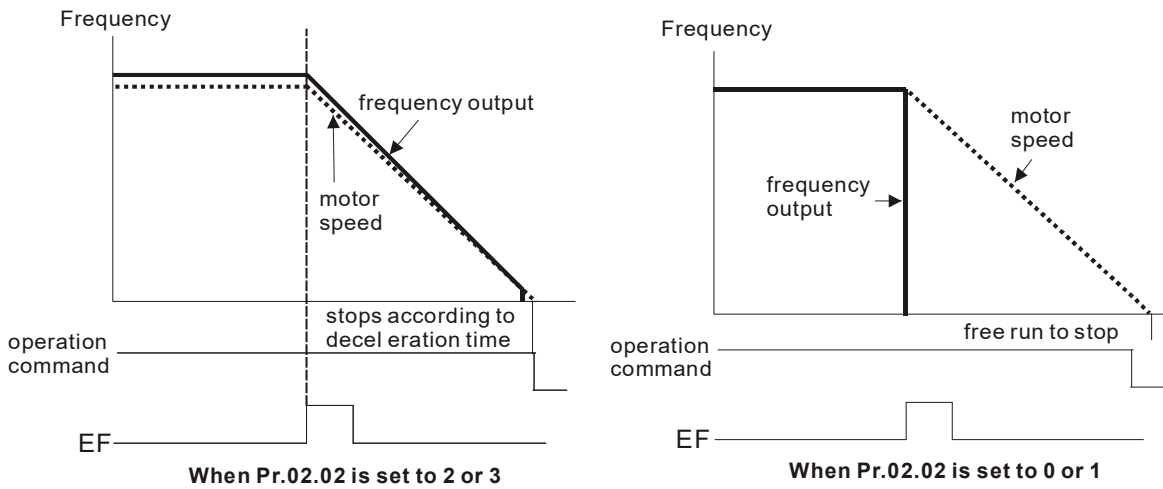
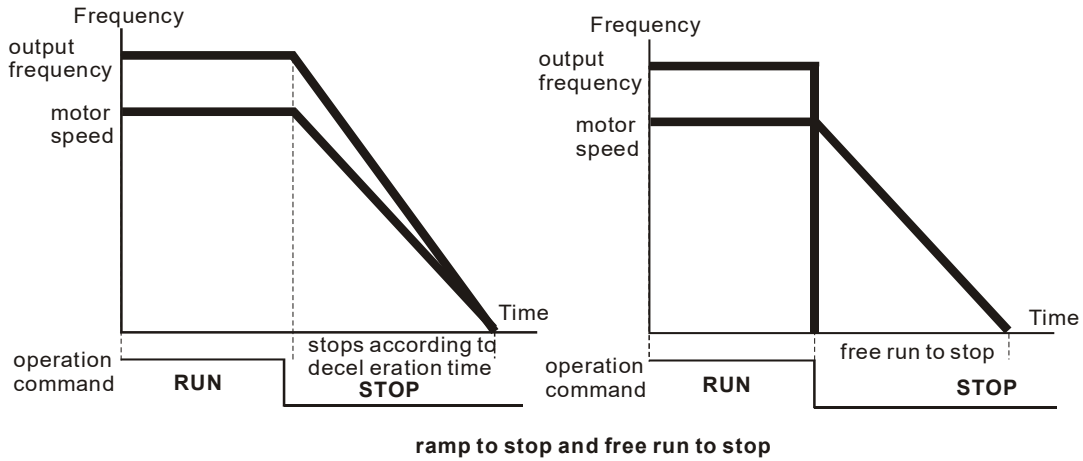

02.03 PWM Carrier Frequency Selection Unit: 1
Default: 8

Settings 2–12 kHz

Determines the PWM carrier frequency of the AC motor drive.

Carrier Frequency	Acoustic Noise	Electromagnetic Noise or leakage current	Heat Dissipation	Current Wave
2kHz	Significant	Minimal	Minimal	Minimal
8kHz	↑	↑	↑	↑
12kHz	Minimal	Significant	Significant	Significant

From the table, you can see that the PWM carrier frequency has a significant influence on the electromagnetic noise, AC motor drive heat dissipation, and motor acoustic noise. The PWM carrier frequency is decreased automatically according to the ambient temperature and output current of the AC motor drives. It is used to prevent the AC motor drive from overheating and thus extend the IGBT's life. Increasing the PWM carrier frequency may reduce the noise of motor operation, but interference measures have to be taken for the consideration of overall wiring.

Take VFD007EL21W(-1) as an example, assume that the ambient temperature is 40°C, the drive output current must be controlled within 100% of the rated current. If the ambient temperature is 50°C, the drive output current should not exceed 80% of the rated current. For other models in an ambient temperature of 50°C, the drive output current must be controlled within 100% of the rated current; for other models in an ambient temperature of 60°C, the drive output current must be controlled within 80% of the rated current.

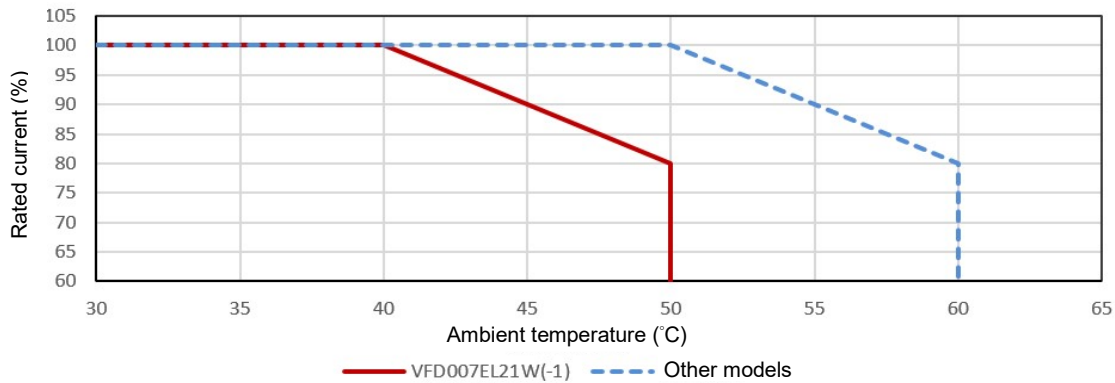

Take VFD007EL21W(-1) as an example, assume that the ambient temperature is 40°C, and default carrier frequency is 8 kHz, then the drive output current reaches 100% of the rated current; if the carrier frequency is 12 kHz, the drive output current must be controlled within 80% of the rated current. If the ambient temperature is 25°C, the installation method is single drive installation, and the carrier frequency is 12 kHz, then the drive reaches 100% of the rated current.

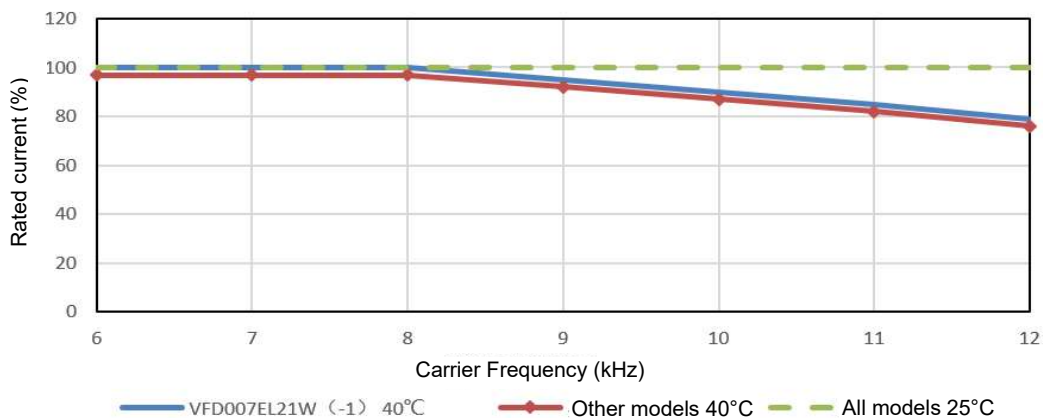

NOTE

Other models: VFD002EL21W(-1), VFD004EL21W(-1), VFD015EL21W(-1), VFD022EL21W(-1), VFD004EL43W(-1), VFD007EL43W(-1), VFD015EL43W(-1), VFD022EL43W(-1), VFD040EL43W(-1)

02.04 Motor Direction Control Default: 0

- Settings
- 0: Forward / Reverse operation enabled
 - 1: Reverse operation disabled
 - 2: Forward operation disabled

Disables one direction of rotation for the AC motor drive.

02.05 Power-On Command and Run Command Source Modifies the Drive Operating Control Default: 1

- Settings
- 0: Start running when power is on.
 - 1: Do not run when power is on.
 - 2: When the source of the command changes, the drive's operation remains the same.
 - 3: When the source of the command changes, the drive's operation follows the new command.
 - 4: The motor drive can start to run at power on or after reset.
When the source of the command is a two-wire external terminal, the operating

command changes as the external terminal's status changes.

 Determines the response of the drive at power-on and when the operation command source is changed.

Pr.02.05	Start lockout (Run when power is ON)	Operation status when operation command source is changed
0	AC motor drive runs	Keeps previous status
1	AC motor drive does not run	Keeps previous status
2	AC motor drive runs	Changes according to the new operation command source
3	AC motor drive does not run	Changes according to the new operation command source
4	AC motor drive runs	Changes as the external terminal's status changes

 Use this parameter to determine whether the AC motor drive receives the operation command or not when the operation command source is the external terminal, the operation command remains, and the AC motor drive power is ON.

- 0: The drive receives the operation command and runs immediately.
- 1: The drive does not receive the operation command. To make the motor run, cancel the operation command, and then input again.
- 4: It is an external terminal control setting when the motor drive restarts after an instantaneous power failure. When the motor drive has an instantaneous power failure, the DC bus decreases to Lv. If you send a command from the host computer while the DC bus is at Lv, and the operating command is still on conductive trigger, the motor drive can be restarted.

 Power-on:

When the operation command source is the external terminal and the operation command is ON (MI1-DCM=closed), the AC motor drive operates according to Pr.02.05 after power is applied.

- When you set Pr.02.05 to 0 or 2 or 4, the AC motor drive runs immediately.
- When you set Pr.02.05 to 1 or 3, the AC motor drive remains stopped until the operation command is received after the previous operation command is cancelled.

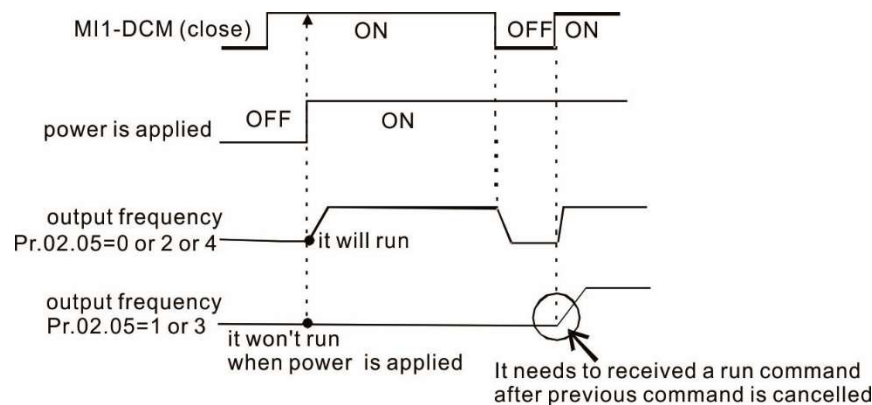

 When the operation command source is not the external terminals, regardless of whether the AC motor drive runs or stops, the AC motor drive operates according to Pr.02.05 if the two conditions below are both met.

- The operation command source is changed to external terminal (Pr.02.01 = 1 or 2)
- The status of the terminal and the AC motor drive are different.

And the operation of the AC motor drive will be:

- When you set Pr.02.05 to 0 or 1, the status of the AC motor drive is not changed by the terminal status.
- When you set Pr.02.05 to 2 or 3 or 4, the status of the AC motor drive is changed by the terminal status.

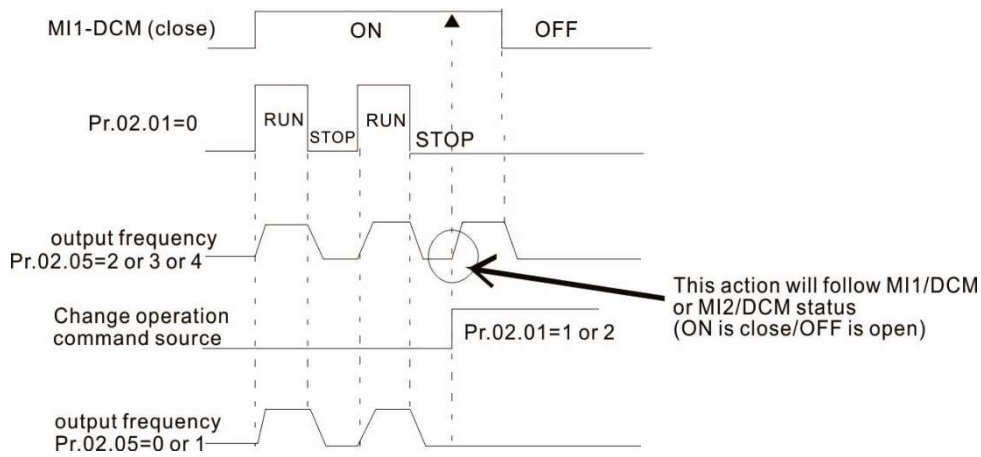

When you set Pr.02.05 to 1 or 3, it does not guarantee that the motor will never run under this condition. It is possible the motor may be set in motion by a malfunctioning switch.

02.06 Loss of ACI Signal (4–20 mA)

Default: 0

- Settings
- 0: Decelerate to 0 Hz
 - 1: Coast to stop and display “AErr”
 - 2: Continue the operation according to the last frequency command
 - 3: Continue the operation according to the setting at Pr.02.11.

Determines the action when ACI signal is lost.

1: Display the warning message “AErr” on the keypad when the ACI signal is lost and execute the Pr.02.06 setting. When the ACI signal is recovered, the warning message atomically stops blinking. You can also press “STOP/RESET” to clear the warning message.

02.07 Up/Down Mode

Default: 0

- Settings
- 0: Digital keypad up/down keys mode
 - 1: Based on Accel./ Decel. Time
 - 2: Constant speed (according to Pr.02.08)
 - 3: Pulse input unit (according to Pr.02.08)

02.08 Accel. / Decel. Rate of Change of UP / DOWN Operation with Constant Speed

Unit: 0.01

Settings 0.01–10.00 Hz/2ms

Default: 0.01

- Determine the increase / decrease of the master frequency when operated through the multi-function inputs and you set Pr.04.06–Pr.04.08 10 (Up command) or 11 (Down command).
- Pr.02.07=0: Use the external terminal’s UP/DOWN keys to increase or decrease the frequency. This is valid only when the AC motor drive is running.
- Pr.02.07=1: Increase and decrease the frequency by the acceleration and deceleration settings. This is valid only when the AC motor drive is running.
- Pr.02.07=2: Increase and decrease the frequency by Pr.02.08 settings.
- Pr.02.07=3: Increase and decrease the frequency according to Pr.02.08 (unit: pulse input). Every ON after OFF is regarded as an input pulse.

02.11 Keypad Frequency Command

Unit: 0.01

Settings 0.00–400.00 Hz

Default: 60.00

Sets the frequency command or reads the keypad frequency command.

02.12	↗ Communication Frequency Command	Unit: 0.01
Settings	0.00–400.00 Hz	Default: 60.00

 Sets the frequency command or reads the communication frequency command.

02.13	Saving Keypad or Communication Frequency Command Selection	Default: 0
Settings	0: Save Keypad & Communication Frequency 1: Save Keypad Frequency Only 2: Save Communication Frequency Only	

 Saves the keypad or RS-485 frequency command.

02.14	Initial Frequency Selection (for Keypad & RS-485)	Default: 0
Settings	0 Current Frequency Command 1 Zero Frequency Command 2 Refer to Pr.02.15 to set up	

02.15	Initial Frequency Setting (for Keypad & RS-485)	Unit: 0.01
Settings	0.00–400.00 Hz	Default: 60.00

 Determines the frequency at stop.
Pr.02.14=0: The initial frequency is the current frequency.
Pr.02.14=1: The initial frequency is 0.
Pr.02.14=2: The initial frequency is the Pr.02.15 setting.

02.16	Display the Master Frequency Command Source	Default: Read Only
Settings	Read Only	

 You can read the master frequency command source from this parameter.

Display Value	Bit	Function
1	bit0=1	The Master Frequency Command Source is the First Master Frequency Source (Pr.02.00).
2	bit1=1	The Master Frequency Command Source is the Second Master Frequency Source (Pr.02.09).
4	bit2=1	The Master Frequency Command Source is the Multi-function input.

02.17	Display the Operation Command Source	Default: Read Only
Settings	Read Only	

 You can read the operation command source from this parameter.

Display Value	Bit	Function
1	bit0=1	Operation Command Source is the Digital Keypad
2	bit1=1	Operation Command Source is the RS-485 communication
4	bit2=1	Operation Command Source is the External Terminal (MI1)
8	bit3=1	Operation Command Source is the Multi-function Input

02.18	User-defined Value 2 Setting	Default: 0
Settings	0–Pr.00.13	

 Reads and writes the user-defined value settings. Changes the operation frequency when Pr.00.13 is not set to 0 and frequency source is from communication.

02.19**User-defined Value 2**

Settings

Read only

Default: 0

 For example, assume that the frequency source is the first frequency + the second frequency command (the first frequency source is the digital keypad and the second frequency source is AVI), the user-defined value 1 is set to 180.0 (Pr.00.13 is set to 1800; Pr.00.14 is set to 1).
 When AVI=2V, the user-defined value is 36.0 [$180.0/(2V/10V)$], and the frequency is 12.0 Hz [$36.0/(180.0/60.0)$].
 When Pr.02.18=30.0, the frequency is 10.0 Hz [$30.0/(60.0/180.0)$].
 At this time, the keypad displays 66.0 (36.0+30.0), and the output frequency is 22.0 Hz (12.0+10.0). If you read the values by using the communication address, the values display as follows: 2102H and 2103H are 22.0 Hz; 0212H (Pr.02.18) is 30.0 Hz; 0213H (Pr.02.19) is 66.0.

Group 3: Output Function Parameters

✎ You can set this parameter during operation.

03.00 Multi-function Output Relay (RA1, RB1, RC1)

Default: 8

Settings 0–25

Settings	Function	Description
0	No Function	There is no function for the output terminals.
1	Indication During Run	Active when the drive is ready or RUN command is ON.
2	Indication of Master Frequency Reached	Active when the AC motor drive reaches the output frequency setting.
3	Zero Speed	Active when Frequency command is lower than the Minimum Output Frequency.
4	Over-Torque Detection	Active when the drive detects over-torque. Pr.06.04 sets the over-torque detection level, and Pr.06.05 sets the over-torque detection time.
5	Base Block (B.B.) Indication	Active when the output of the AC motor drive is shut off during Base Block. You can force Base Block with the multi-function input (setting 09).
6	Low-Voltage Indication	Active when low voltage (Lv) is detected.
7	Operation Mode Indication	Active when the operation command is controlled by the external terminal.
8	Fault Indication	Active when the drive detects abnormal conditions; the contact will be closed (example: oc, ov, oH1, oL, oL1, EF, cF3.0–5, HPF1, 2, 4, ocA, ocd, ocn).
9	Desired Frequency Reached	Active when the desired frequency (Pr.03.02) is reached.
10	Terminal Count Value Reached	Active when the counter reaches the Terminal Count Value.
11	Preliminary Count Value Reached	Active when the drive executes the external counter if the count value is equal to the setting value for Pr.03.06.
12	Over-voltage Stall Prevention	Active when the Over-voltage Stall Prevention function is operating.
13	Over-current Stall Prevention	Active when the Over-current Stall Prevention function is operating.
14	IGBT Overheat Warning	When the IGBT overheats, it signals to prevent OH from turning off the drive. When the temperature is higher than 85°C (185°F), it is ON. When it is lower than 80°C (180°F), it is OFF.
15	Over-voltage	Active when the DC bus voltage exceeds the setting level.
16	PID Feedback Error	Active when the PID feedback signal is abnormal (refer to Pr.10.08 and Pr.10.12).
17	Forward Command	Active when the direction command is FWD.
18	Reverse Command	Active when the direction command is REV.
19	Zero Speed Output Signal	Active when the drive is in standby or stop.
20	Warning	Active when there is a communication warning (CExx, AoL2, AUE, FbE, SAvE).
21	Mechanical Brake Control (Desired Frequency Reached)	Active when the output frequency \geq Pr.03.11. Deactivated when the output frequency \leq Pr.03.12 after STOP command.
22	Drive Ready	Active when the drive is on and no abnormality is detected.
23	Multi-pump System Error Display (Only Master)	If any error occurred on the drive for the multi-pump system, the RLY outputs.

Settings	Function	Description
24	Preheating Function Indication	Active when the preheating function is enabled.
25	Fire Mode Indication	Active when MI is set to 27 or 28 (fire mode).

※ “Active” means ON or low voltage.

03.01	Reserved
--------------	----------

03.02	Desired Frequency Reached	Unit: 0.01
Settings	0.00–400.0 Hz	Default: 0.00

📖 If you set a multi-function output terminal to function as Desired Frequency Reached (Pr.03.00–Pr.03.01 = 09), then the output is activated when the output frequency reaches the Pr.03.02 setting.

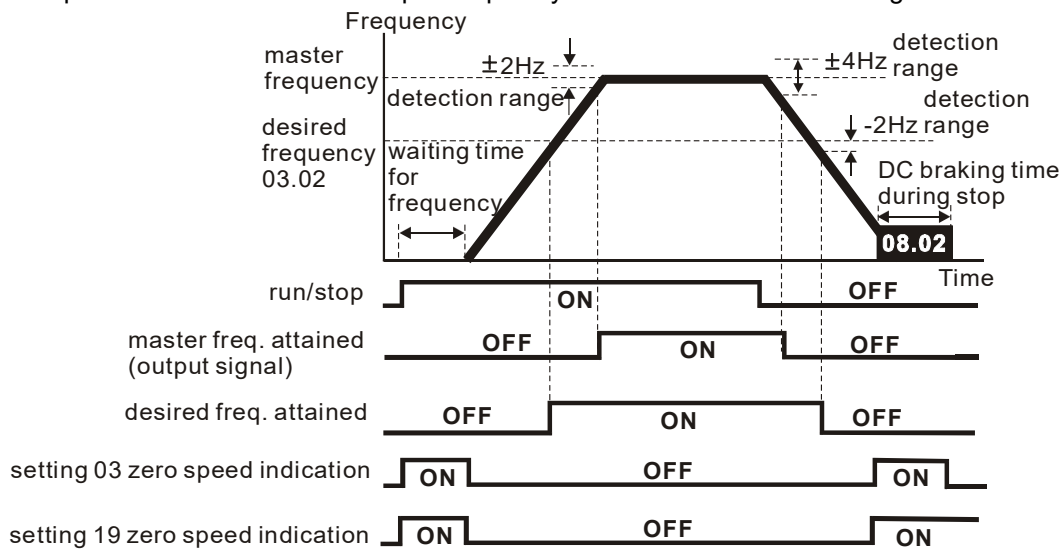

output timing chart of multiple function terminals when setting to frequency attained or zero speed indication

03.03	Reserved
--------------	----------

03.04	Reserved
--------------	----------

03.05	Terminal Count Value	Unit: 1
Settings	0–9999	Default: 0

📖 Sets the count value of the internal counter.
 You can use the external multi-function input terminals on the control terminals to trigger the counter. When the count reaches the setting value, the specified output terminal activates by setting one of the multi-function input terminals (the count value resets after reaching the setting for Pr.03.05).

NOTE

When the display shows c555, the drive has counted 555 times. If the display shows c555•, it means that the actual counter value is between 5,550 and 5,559.

03.06	Preliminary Count Value	Unit: 1
Settings	0–9999	Default: 0

📖 When the counter value counts from c1 to this setting value, the corresponding multi-function output terminal activates. You can use it as an indication for the AC motor drive running at low speed to stop when the counting is going to reach the setting value before stop.

📖 The timing diagram shows as follows:

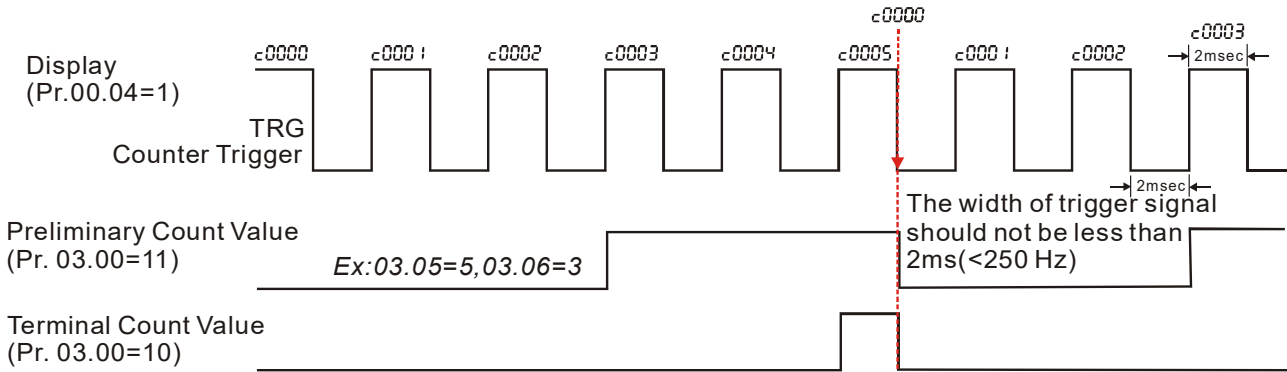

03.07 EF Active when Terminal Count Value Reached

Default: 0

- Settings
- 0: Terminal count value reached, no EF display.
 - 1: Terminal count value reached, EF active.

If you set this parameter to 1 and the desired counter setting value is reached, the AC motor drive treats it as a fault. The drive stops and shows the “EF” message on the display. The AC motor drive continues to run until you press RESET.

03.08 Fan Control

Default: 0

- Settings
- 0: Fan is always ON.
 - 1: One minute after the AC motor drive stops, the fan is OFF.
 - 2: Fan is ON when the AC motor drive runs, fan is OFF when the AC motor drive stops.
 - 3: Fan is ON when the preliminary heat sink temperature is reached.
 - 4: Fan is ON when the AC motor drive runs; fan is OFF when the AC motor drive stops. And the fan is in a standby mode at 0 Hz.

Determines the operation mode of the cooling fan.

This parameter is only valid for fan cooling models. The 1 HP models have no fans (convective cooling) so this parameter cannot be used for 1 HP models.

03.09 Reserved

03.10 Reserved

03.11 Mechanical Brake Release Frequency

Unit: 0.01

Settings 0.00–20.00 Hz

Default: 0.00

03.12 Mechanical Brake Engage Frequency

Unit: 0.01

Settings 0.00–20.00 Hz

Default: 0.00

These two parameters set control of the mechanical brake through the output terminals (Relay) by setting Pr.03.00 to 21. Refer to the following example for details.

Example:

1. Case 1: Pr.03.12 \geq Pr.03.11
2. Case 2: Pr.03.12 \leq Pr.03.11

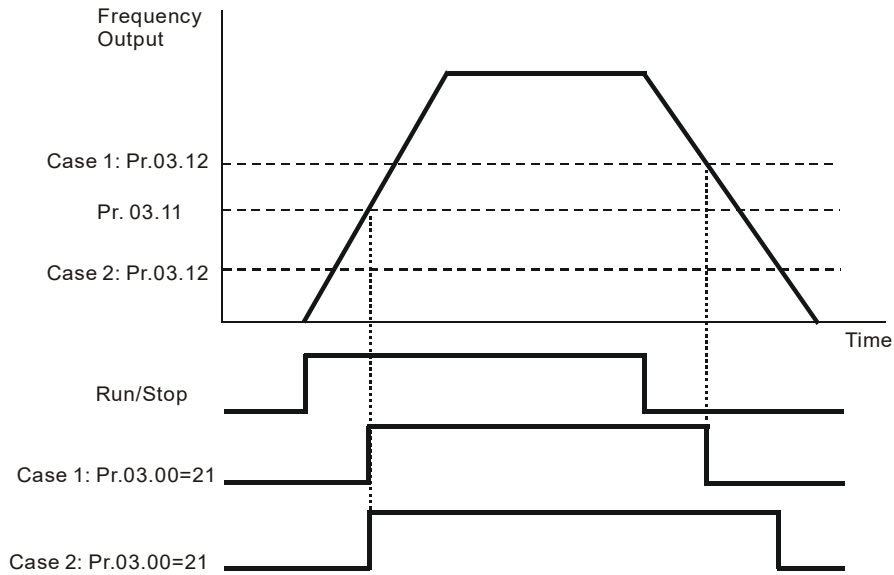

 Pr.03.00 multi-function output terminal 21 (Mechanical Brake Control): When the output frequency reaches Pr.03.11 (Mechanical Brake Release Frequency), the multi-function output terminal is closed. When the output frequency reaches Pr.03.12 (Mechanical Brake Engage Frequency), the multi-function output terminal is open.

03.13 Display the Status of the Multi-function Output Terminals

Settings

Read Only

Default: Read Only

 For the standard AC motor drive, the multi-function output terminals are falling-edge triggered.

 0: Relay is ON; 1: Relay is OFF.

Group 4: Input Function Parameters

✎ You can set this parameter during operation.

04.00	✎ Keypad Potentiometer Bias	Unit: 0.1
Settings	0.0–100.0%	Default: 0.0
04.01	✎ Keypad Potentiometer Bias Polarity	Default: 0
Settings	0: Positive Bias 1: Negative Bias	
04.02	✎ Keypad Potentiometer Gain	Unit: 0.1
Settings	0.1–200.0%	Default: 100.0
04.03	Keypad Potentiometer Negative Bias, Reverse Motion Enable/Disable	Default: 0
Settings	0: No Negative Bias Command 1: Negative Bias: REV Motion Enabled	

📖 Use Pr.04.00–04.03 for applications that use the potentiometer signal on the digital keypad to adjust the setting frequency. The potentiometer is not an external device, but you need to use it when setting parameters. Refer to the following examples to know how to use it.

📖 As shown in the left figure below, operating the potentiometer on the digital keypad to the leftmost means the minimum value that the lowest voltage 0 V_{DC} corresponds to. As shown in the right figure below, operating the potentiometer on the digital keypad to the rightmost means the maximum value that the highest voltage 5 V_{DC} corresponds to.



The minimum



The maximum

Example 1:

You set Pr.02.00 to 4 (the master frequency command comes from keypad potentiometer), set Pr.04.00~04.03 to defaults, and then you can set the main frequency command through the keypad potentiometer.

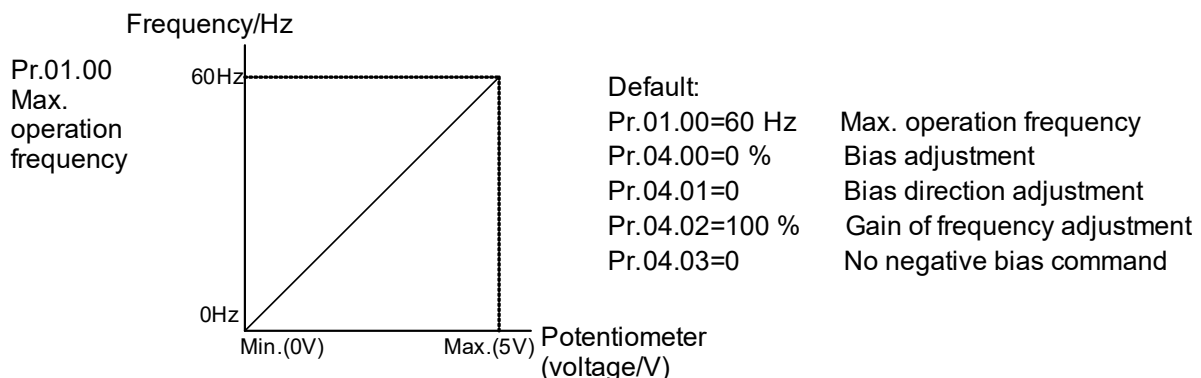

Example 2:

If you want the corresponded minimum value to be 12 Hz (the master frequency setting) when operating the keypad potentiometer to the leftmost, and you set other frequency settings, refer to the diagram below. The correspondence between the keypad potentiometer (voltage) and setting frequency has been changed from 0–5 V (min.–max.) / 0–60 Hz to 0–4 V / 0–60 Hz. Therefore, the 4 V and above from the keypad potentiometer all correspond to 60 Hz. To use the full potentiometer range, refer to Example 3.

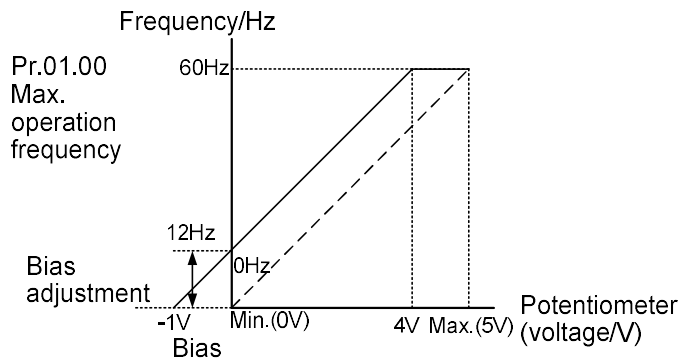

- Default:
- Pr.01.00=60 Hz Max. operation frequency
 - Pr.04.00=20 % Bias adjustment
 - Pr.04.01=0 Bias direction adjustment
 - Pr.04.02=100 % Gain of frequency adjustment
 - Pr.04.03=0 No negative bias command

To count the bias (See α in the formula)

$$\frac{60-0 \text{ Hz}}{5\text{V}} = \frac{12-0 \text{ Hz}}{\alpha\text{V}} \rightarrow \alpha=1\text{V}$$

$$\therefore \text{Pr.04.00} = \frac{1\text{V}}{5\text{V}} \times 100\% = 20\%$$

Example 3:

As shown in this example, the keypad potentiometer can be used for all ranges of 0–5 V / 0–60 Hz settings. This increases flexibility.

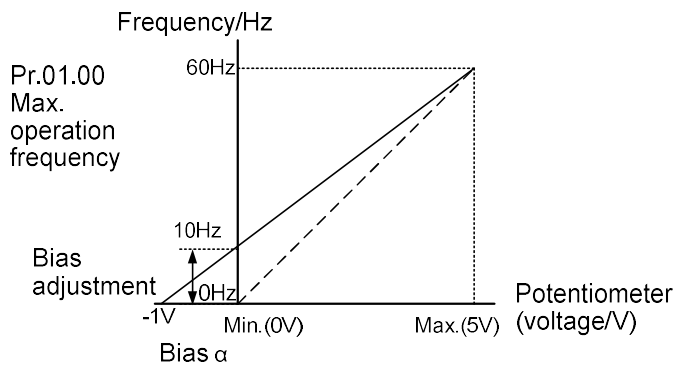

- Default:
- Pr.01.00=60 Hz Max. operation frequency
 - Pr.04.00=20 % Bias adjustment
 - Pr.04.01=0 Bias direction adjustment
 - Pr.04.02=83.3 % Gain of frequency adjustment
 - Pr.04.03=0 No negative bias command

To count the bias (See α in the formula)

$$\frac{60-10 \text{ Hz}}{5\text{V}} = \frac{10-0 \text{ Hz}}{\alpha\text{V}} \rightarrow \alpha=1\text{V}$$

$$\therefore \text{Pr.04.00} = \frac{1\text{V}}{5\text{V}} \times 100\% = 20\%$$

To count the gain value

$$\text{Pr.04.02} = \frac{5\text{V}}{[5-(-1)]\text{V}} \times 100\% = 83.3\%$$

Example 4:

This example shows how to use the first half range 0–2.5 V (min.–1/2 * max.) from the keypad potentiometer to set 0–60 Hz frequency settings. You can achieve the same results by either adjusting Pr.04.02 gain or setting Pr.01.00 to 120 Hz.

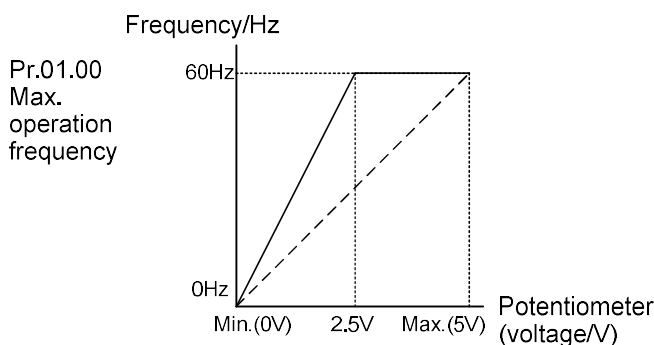

- Default:
- Pr.01.00=60 Hz Max. operation frequency
 - Pr.04.00=0.0 % Bias adjustment
 - Pr.04.01=0 Bias direction adjustment
 - Pr.04.02=200 % Gain of frequency adjustment
 - Pr.04.03=0 No negative bias command

To count the gain value

$$\text{Pr.04.02} = \frac{5\text{V}}{(5-2.5)\text{V}} \times 100\% = 200\%$$

Example 5:

This example uses a 1 V negative bias. In noisy environments, negative bias can be useful to provide a noise margin (1 V in this example).

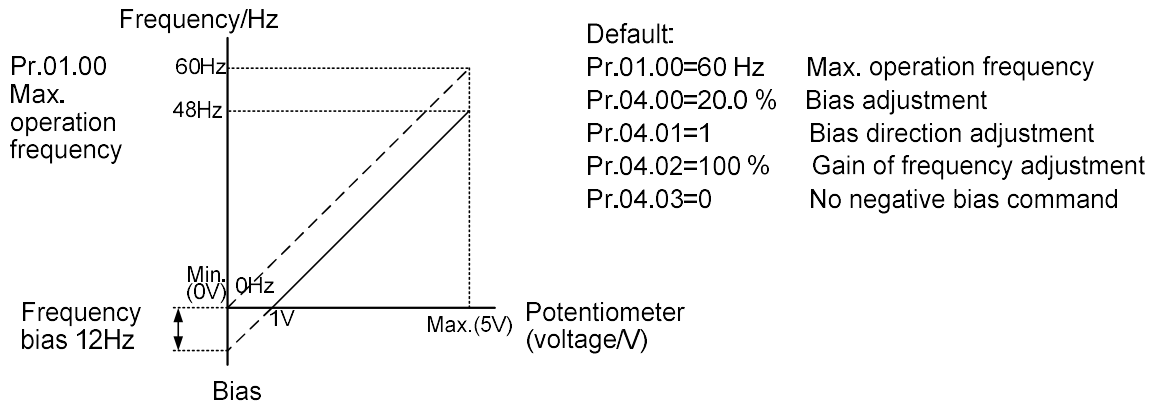

Example 6:

This example uses a negative bias to provide a noise margin. In addition, it uses a potentiometer frequency gain to reach the Maximum Output Frequency.

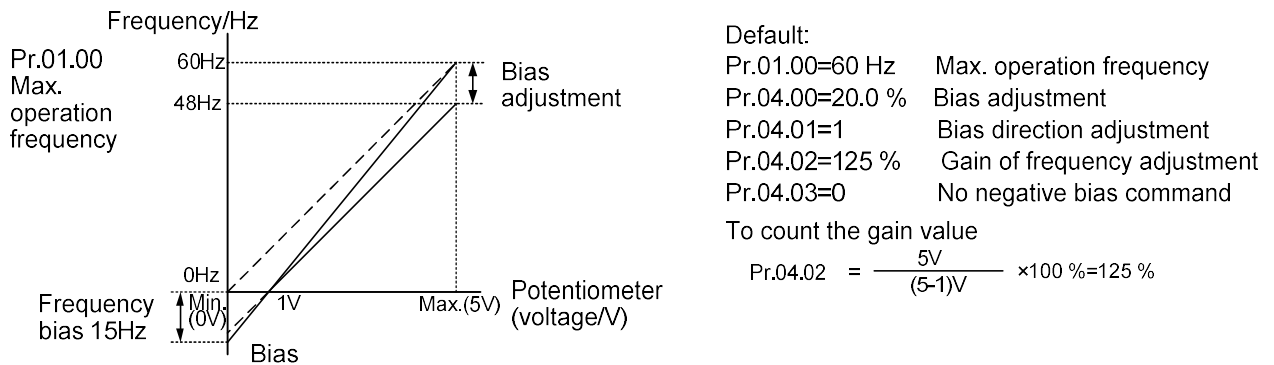

Example 7:

In this example, you perform the input to run the motor in both the forward and reverse directions. The motor is idle when the potentiometer position is at its mid-point. Using the settings in this example disables the external FWD and REV controls.

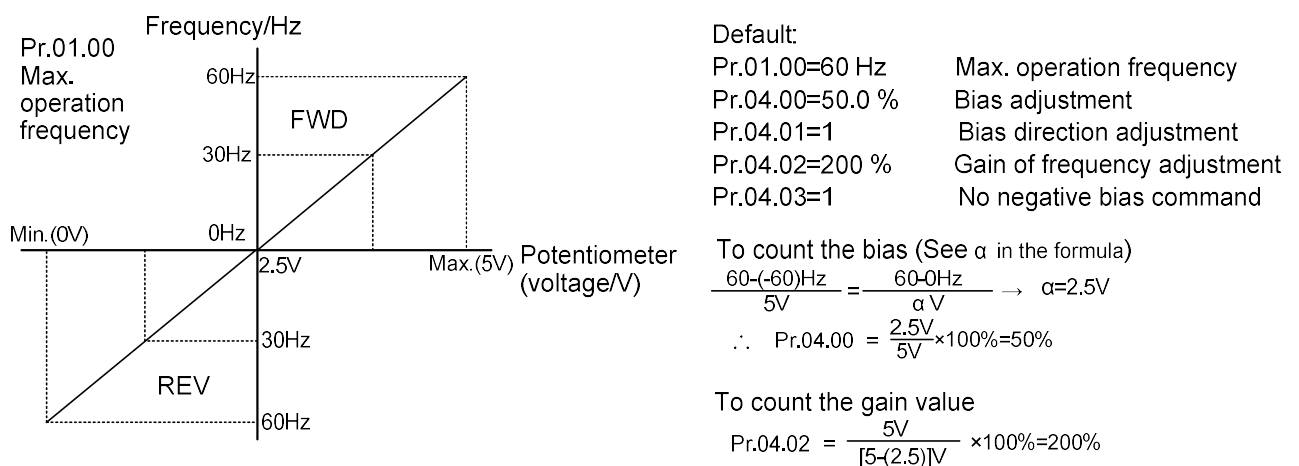

Example 8:

This example uses negative slope. With these settings, the AC motor drive always runs in only one direction (reverse).

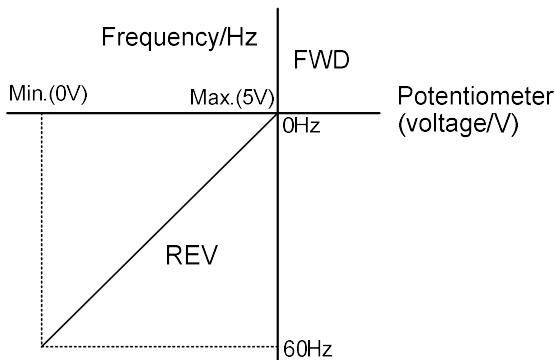

Default:

- Pr.01.00=60 Hz
- Pr.04.00=100 %
- Pr.04.01=1
- Pr.04.02=100 %
- Pr.04.03=1

- Max. operation frequency
- Bias adjustment
- Bias direction adjustment
- Gain of frequency adjustment
- No negative bias command

04.11 Minimum AVI Voltage

Unit: 0.1
Default: 0.0

Settings 0.0–10.0 V

04.12 Minimum AVI Frequency (percentage of Pr.01.00)

Unit: 0.1
Default: 0.0

Settings 0.0–100.0 % [100% corresponds to Fmax (Pr.01.00)]

04.13 Maximum AVI Voltage

Unit: 0.1
Default: 10.0

Settings 0.0–10.0 V

04.14 Maximum AVI Frequency (percentage of Pr.01.00)

Unit: 0.1
Default: 100.00

Settings 0.00–100.00% [100% corresponds to Fmax (Pr.01.00)]

04.15 Minimum ACI Current

Unit: 0.1
Default: 4.0

Settings 0.0–20.0 mA

04.16 Minimum ACI Frequency (percentage of Pr.01.00)

Unit: 0.1
Default: 0.0

Settings 0.00–100.00% [100% corresponds to Fmax (Pr.01.00)]

04.17 Maximum ACI Current

Unit: 0.1
Default: 20.0

Settings 0.0–20.0 mA

04.18 Maximum ACI Frequency (percentage of Pr.01.00)

Unit: 0.1
Default: 100.0

Settings 0.00–100.00% [100% corresponds to Fmax (Pr.01.00)]

These parameters set the analog input reference values. The minimum and maximum frequencies are set based on Pr.01.00 (during open-loop control) as shown in the following diagrams.

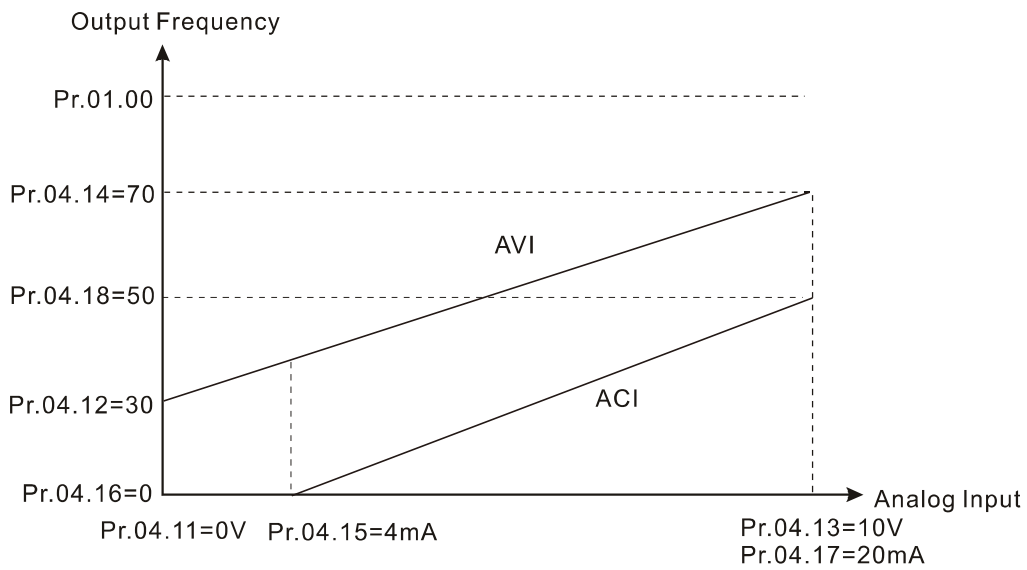
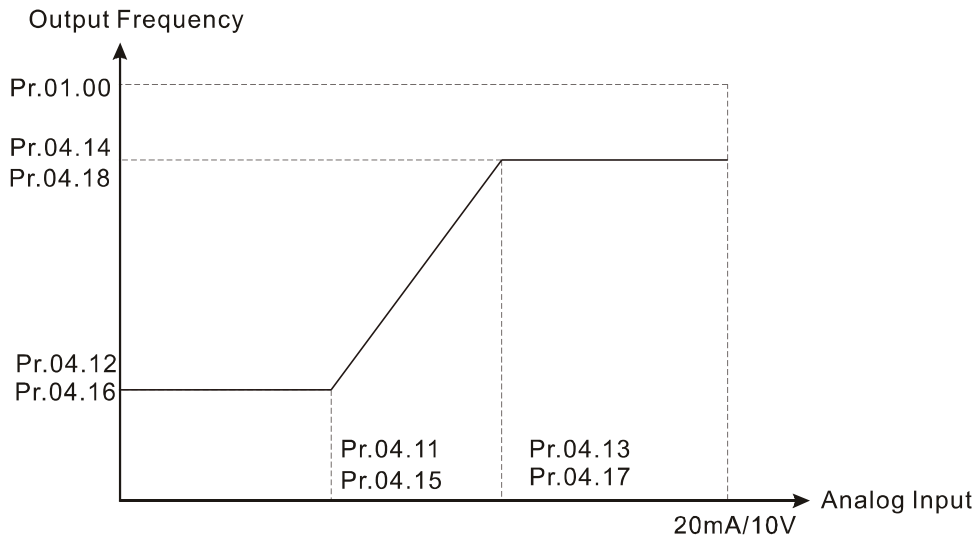

04.19 MI Terminal Control Mode Selection

Default: 0

- Settings
- 0: Mode 1
(MI1: Start-up/Stop terminal; MI2 & MI3: multi-function input terminals)
 - 1: Mode 2
(MI1/MI2/MI3 support two-wire/three-wire start-up)

- 📖 Determines the MI terminal control modes.
- 📖 Mode 1: MI1 is the start-up/stop terminal; MI2 and MI3 are the multi-function input terminals.
- 📖 Mode 2: MI1, MI2 and MI3 support the two-wire / three-wire start-up.

04.20	Reserved
04.21	Reserved
04.22	Reserved
04.23	Reserved
04.24	Reserved
04.25	Reserved

04.04 Start-up / Stop Method of MI Terminals and Multi-function Input Selection

Default: 0

Settings

- Mode 1 0: MI1 Start-up (keypad FWD lights) / Stop
(Pr.04.19=0)
- Mode 2 0: Two-wire (1) MI1, MI2
(Pr.04.19=1)
 1: Two-wire (2) MI1, MI2
 2: Three-wire, MI1, MI2, MI3

- Pr.04.19 determines the setting range and function for Pr.04.04.
- Mode 1 (Pr.04.19=0): MI1 controls the start-up / stop, and MI2 / MI3 / MI4 are set as multi-function terminals.
- Mode 2 (Pr.04.19=1): two-wire (1)/two-wire (2) MI1 and MI2 are used for start-up/stop and forward/reverse control; MI3 and MI4 are set as multi-function terminals; three-wire (MI1, MI2 and MI3) are used for start-up/stop and forward/reverse control; MI4 is set as the multi-function terminal.
- There are four different control modes:

Setting for Pr.04.19	Setting for Pr.04.04	External terminal control circuit
Mode 1 Pr.04.19=0	Pr.04.04=0 Single-wire FWD/STOP	<p>MI1: "OPEN":STOP, "CLOSE": FWD MI2: Multi-function terminal MI3: Multi-function terminal DCM</p> <p style="text-align: right;">VFD-EL-W</p>
Mode 2 Pr.04.19=1	Pr.04.04=0 Two-wire (1) FWD/STOP, REV/STOP	<p>MI1: "OPEN":STOP, "CLOSE": FWD MI2: "OPEN": STOP, "CLOSE": REV MI3: Multi-function terminal DCM</p> <p style="text-align: right;">VFD-EL-W</p>
	Pr.04.04=1 Two-wire (2) RUN/STOP, REV/FWD	<p>MI1: "OPEN":STOP, "CLOSE": RUN MI2: "OPEN": FWD, "CLOSE": REV MI3: Multi-function terminal DCM</p> <p style="text-align: right;">VFD-EL-W</p>
	Pr.04.04=2 Three-wire Operation Control	<p>MI1: "CLOSE": RUN MI3: "OPEN": STOP MI2: "OPEN": FWD, "CLOSE": REV DCM</p> <p style="text-align: right;">VFD-EL-W</p>

04.05	Reserved	
04.06	Start-up/Stop or Multi-function Input Terminal (MI2)	Default: 1
04.07	Start-up/Stop or Multi-function Input Terminal (MI3)	Default: 2
04.08	Multi-function Input Terminal (MI4)	Default: 3
Settings 0-28		

Settings	Function	Description
0	No Function	Program any unused terminals to 0 to ensure they have no effect on operations.
1	Multi-Step Speed Command 1	Use these three terminals to set the seven-step speed operation. There are nine step speed frequencies (including Master Frequency and Jog Frequency) available.
2	Multi-Step Speed Command 2	
3	Multi-Step Speed Command 3	
4	Reserved	

Settings	Function	Description
5	External Reset	Use this terminal to reset the drive after drive faults are cleared.
6	Accel./ Decel. Inhibit	<p>When you enable this function, the drive stops acceleration and deceleration immediately. The AC motor drive resumes from the inhibit point once this function is disabled.</p>
7	The 1 st , 2 nd acceleration or deceleration time selection	<p>Selects the acceleration and deceleration time of the drive with this terminal; there are two acceleration and deceleration selections.</p>
8	JOG Operation Control	Executes the JOG operation only when the drive stops completely. While running, you can still change the operation direction, and the STOP key on the keypad is valid. Once the external terminal receives the OFF command, the motor stops in the JOG deceleration time. Refer to Pr.01.13–Pr.01.15 for details.
9	External Base Block (Refer to Pr.08.06)	<p>When the AC motor drive receives a Base Block signal, it blocks all output and the motor coasts. When Base Block control is deactivated, the AC drive starts its speed search function and synchronizes with the motor speed. It then accelerates to the Master Frequency. Refer to Pr.08.06–Pr.08.07 for details.</p>
10	UP: Increase Master Frequency	ON: the frequency of the drive increases or decreases by one unit. If this function remains ON continuously, the frequency increases or decreases according to Pr.02.07 / Pr.02.08 settings.

Settings	Function	Description
11	DOWN: Decrease Master Frequency	These two functions are the same as the up / down key on the digital keypad, but are only valid when the frequency command source is set as digital keypad (Pr.02.00 / 02.09=0). You cannot use these two functions to change the parameter setting.
12	Counter Trigger	Uses external signals such as connecting ON/OFF switch, lightening sensor, etc., to trigger the counter. You can also use signals of the multi-function output terminal (counter reached, desired counter reached) to control the applications that based on the counter. For example: winding machine, packing machine. (Refer to Pr.03.05 and Pr.03.06 for details.)
13	Counter Reset	ON: the current counter value is cleared and displays "c 0". The drive starts to count up only when this function is disabled.
14	External Fault	When the drive receives status change from the EF terminal, the output of the drive stops immediately, and displays EF on the keypad. The motor coasts. The drive keeps running until the fault is cleared after you press RESET on the keypad (EF: External Fault).
15	PID function disabled	ON: the PID function is disabled.
16	Output Shutoff Stop	AC motor drive stops output and the motor coasts if one of these settings is enabled. If the status of terminal is changed, AC motor drive restarts from 0 Hz.
17	Parameter lock enable	Locks all parameters and disables writing parameters.
18	Operation Command Selection (Pr.02.01 setting/external terminals)	ON: Operation command through External Terminals OFF: Operation command through Pr.02.01 setting When 18, 19, and 20 are ON at the same time, the priority is settings 18 > setting 19 > setting 20.
19	Operation Command Selection (Pr.02.01 setting/Digital Keypad)	ON: Operation command through Digital Keypad OFF: Operation command through Pr.02.01 setting When 18, 19 and 20 are ON at the same time, the priority is setting 18 > setting 19 > setting 20.
20	Operation Command Selection (Pr.02.01 setting/Communication)	ON: Operation command through the Communication OFF: Operation command through Pr.02.01 setting When 18, 19 and 20 are ON at the same time, the priority is setting 18 > setting 19 > setting 20.
21	Forward/Reverse	This function has top priority to set the running direction (If "Pr.02.04=0").
22	Second frequency command source enabled	Select the first or second Frequency command source. Refer to Pr.02.09. ON: Second Frequency command source OFF: First Frequency command source
23	Simple positioning stop by forward limit	If a motor receives such signal while running forward, it stops running forward.
24	Simple positioning stop by reverse limit	If a motor receives such signal while running in reverse, it stops running in reverse.
25	Multi-pump control by Hand or Auto mode	When this function is enabled, switch to hand or auto mode from this terminal.
26	Auto-trigger preheating function	When this function is enabled, control the motor preheating function from this terminal.
27	Fire mode enabled (without Operation Command)	When this function is enabled, the fire mode is activated. The drive displays fire message but does not run automatically. You must give the operation command to make the drive run.
28	Fire mode enabled (with Operation Command)	When this function is enabled, the fire mode is activated. The drive displays fire message, runs and automatically accelerates to Pr.08.24 setting values.

04.09 Multi-function Input Contact Selection

Unit: 1

Settings 0–63

Default: 0

- ☞ Sets the contact status of external multi-function input terminals MI2–MI4 to be normally open (N.O.) or normally closed (N.C.) according to the start-up / stop mode (Pr.04.19 and Pr.04.04).
- ☞ When the start-up/stop mode is single-wired, MI1 setting is invalid; when the start-up/stop mode is two-wired, MI2 setting is invalid; when the start-up/stop mode is three-wired, MI2 and MI3 settings are invalid. See the table below for details.

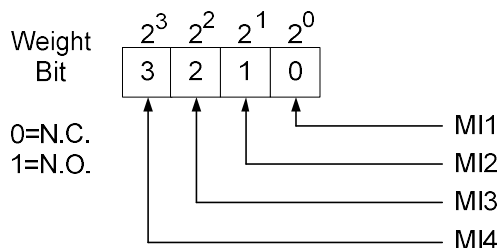

Start-up / Stop Mode		MI4	MI3	MI2	MI1	The Setting of the MI Terminals		
Mode	Pr.04.19	Pr.04.04	Bit 3	Bit 2	Bit 1	Bit 0	Multi-function Input Terminals	The Terminals Occupied by the Start-up / Stop Function
Single-wire	0	0	0/1	0/1	0/1	-	MI4, MI3, MI2 can be set as N.O. or N.C.	MI1 is only controlled by external terminals
Two-wire	1	0 or 1	0/1	0/1	-	-	MI4, MI3 can be set as N.O. or N.C.	MI1, MI2 are only controlled by external terminals
Three-wire	1	2	0/1	-	-	-	MI4 can be set as N.O. or N.C.	MI1, MI2, MI3 are only controlled by external terminals

- ☞ Setting method: When setting this parameter, convert Bit3–Bit0 that represent the status of MI4–MI1 from binary to decimal.

For example: setting MI3 and MI4 to be 1 = N.C.; setting MI1 and MI2 to be 0 = N.O.
The setting value for Pr.04.09 should be 12.

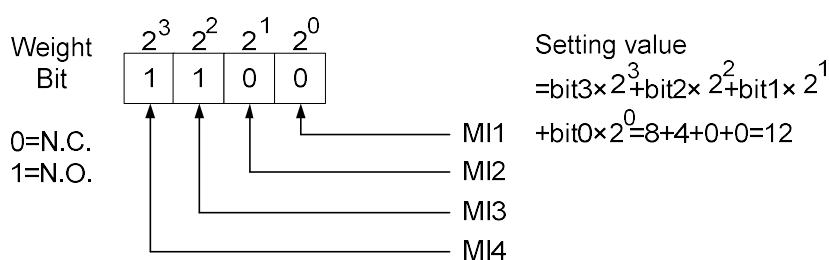
**04.10** Digital Terminal Input Response Time

Unit: 1 msec

Settings 1–20 (*2ms)

Default: 1

- ☞ This parameter delays the signals on digital input terminals. A value of 1=2 ms, 2=4 ms, and so on. The delay time helps with noisy signals that could cause the digital terminals to malfunction. This parameter could effectively improve the interference, but the response time will be delayed.

04.26 Display the Status of Multi-function Input Terminal

Settings Read Only

Default: Read Only

- ☞ Displays 63 in Pr.04.26 when all the MI terminals are not active.
 1. When MI1 (corresponds to bit0) is triggered, and the weight is 1, Pr.04-26=62 (63-1).
 2. When MI2 (corresponds to bit1) is triggered, and the weight is 2, Pr.04-26=61 (63-2).

3. When MI3 (corresponds to bit2) is triggered, and the weight is 4, Pr.04-26=59 (63-4).
4. When MI4 (corresponds to bit3) is triggered, and the weight is 8, Pr.04-26=55 (63-8).
5. If more than one MI terminals are triggered, use 63 minus the weight that corresponds to the MI terminal.

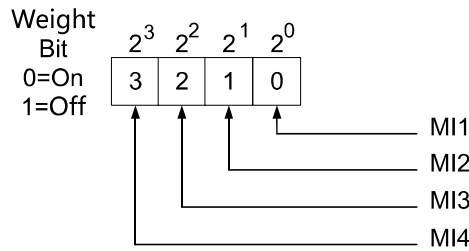

For example, if you set MI2 and MI3 to ON, Pr.04.26 displays 57 (63-2-4=57, decimal)

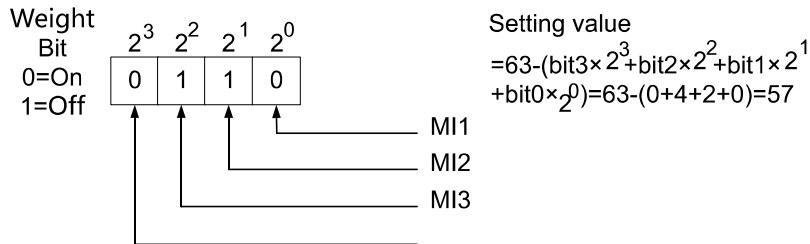

04.27 Internal/External Multi-function Input Terminals Selection Unit: 1
 Settings 0-4095 Default: 0

Selects the terminals MI1-MI4 to be either internal terminal or external terminal. You can activate internal terminals with Pr.04.28. A terminal cannot be both an internal terminal and an external terminal at the same time.

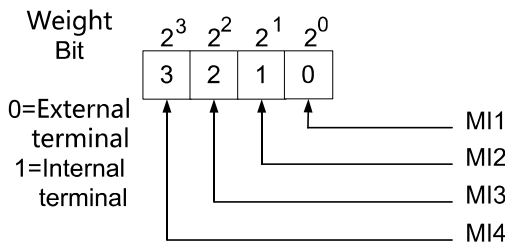

When setting this parameter, convert Bit3-Bit0 that represent the status of MI4-MI1 from binary to decimal. Set MI3 and MI4 as internal terminals; set MI1 and MI2 as external terminals. Pr.04-27 should be set to 12.

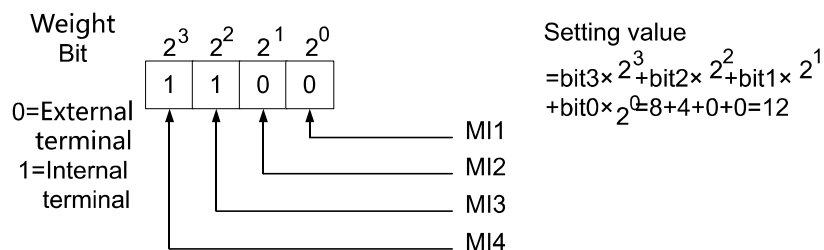

04.28 Internal Terminal Status Unit: 1
 Settings 0-4095 Default: 0

Sets the internal terminal action (ON/OFF) through the keypad or communication. And use this parameter with Pr.04.27.

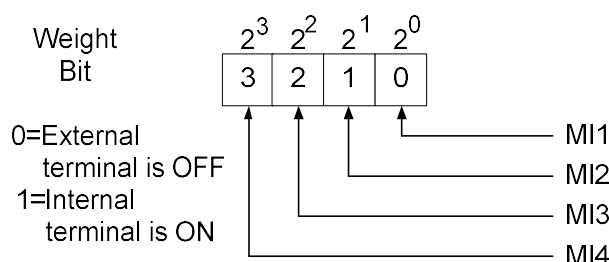

For example, to activate MI3 and MI4, set Pr.04.28 to 12.

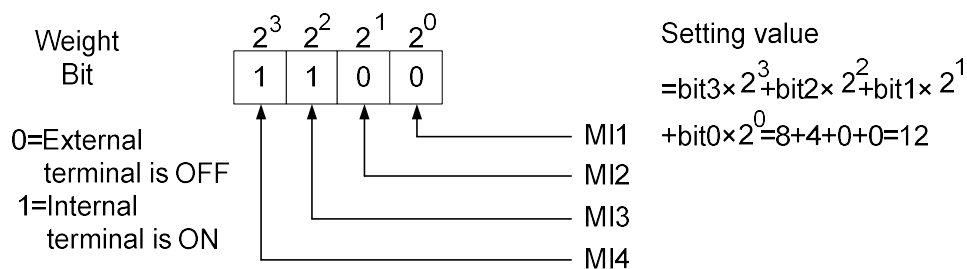

04.29	Delay Time of Multi-function Input Terminal (MI1) Turn On		
Settings	0.00–360.00 sec.		Default: 0.00
04.30	Delay Time of Multi-function Input Terminal (MI1) Turn Off		
Settings	0.00–360.00 sec.		Default: 0.00
04.31	Delay Time of Multi-function Input Terminal (MI2) Turn On		
Settings	0.00–360.00 sec.		Default: 0.00
04.32	Delay Time of Multi-function Input Terminal (MI2) Turn Off		
Settings	0.00–360.00 sec.		Default: 0.00
04.33	Delay Time of Multi-function Input Terminal (MI3) Turn On		
Settings	0.00–360.00 sec.		Default: 0.00
04.34	Delay Time of Multi-function Input Terminal (MI3) Turn Off		
Settings	0.00–360.00 sec.		Default: 0.00

The delay function of multi-function input terminals ON/OFF: In the testing process of automatic production line, the conveyor uses photoelectric switch as a triggered switch for the position reached, which means the conveyor stops once the product arrives the specified position. However, there may be a difference between the installation position of the photoelectric switch and the specified position the product arrives. Therefore, this delay time function is added for the convenience of tuning.

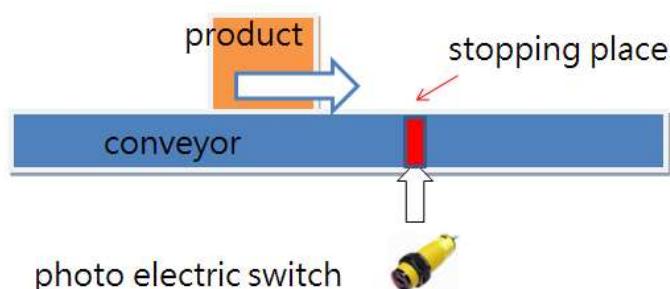

Group 5: Multi-Step Speed Parameters

✎ You can set this parameter during operation.

05.00	✎ 1st Step Speed Frequency	Unit: 0.01
05.01	✎ 2nd Step Speed Frequency	Unit: 0.01
05.02	✎ 3rd Step Speed Frequency	Unit: 0.01
05.03	✎ 4th Step Speed Frequency	Unit: 0.01
05.04	✎ 5th Step Speed Frequency	Unit: 0.01
05.05	✎ 6th Step Speed Frequency	Unit: 0.01
05.06	✎ 7th Step Speed Frequency	Unit: 0.01
Settings 0.00–400.00Hz		Default: 0.00

 The multi-function input terminals (refer to Pr.04.06–Pr.04.08) select one of the AC motor drive multi-step speeds (maximum of seven speeds). The speeds (frequencies) are determined by Pr.05.00–Pr.05.06 as shown in the following table.

	Parameter	Multi-step speed command 1	Multi-step speed command 2	Multi-step speed command 3
Master frequency	Master speed	OFF	OFF	OFF
1 st speed	05.00	ON	OFF	OFF
2 nd speed	05.01	OFF	ON	OFF
3 rd speed	05.02	ON	ON	OFF
4 th speed	05.03	OFF	OFF	ON
5 th speed	05.04	ON	OFF	ON
6 th speed	05.05	OFF	ON	ON
7 th speed	05.06	ON	ON	ON

Group 6: Protection Parameters

✎ You can set this parameter during operation.

06.00	Over-Voltage Stall Prevention		Unit: 0.1
Settings	230V series	330.0–410.0V	Default: 390.0
	460V series	660.0–820.0V	Default: 780.0

- 📖 The default for 230V series is 390.0; the default for 460V series is 780.0.
- 📖 0.0: Disables the Over-voltage Stall Prevention (with brake unit or brake resistor)
- 📖 During deceleration, the DC bus voltage may exceed its Maximum Allowable Value due to motor regeneration. When this function is enabled, the AC motor drive does not decelerate further and keep the output frequency constant until the voltage drops below the preset value again.
- 📖 This parameter is suitable for uncertain load inertia. In normal inertia load condition, over-voltage stall prevention does not occur and the actual deceleration time is the deceleration time setting. However, when the load inertia is large, the AC motor drive automatically increases the deceleration time until it stops. You can also install a brake resistor to absorb the excessive regenerative voltage. If the deceleration time affects your application, it is not recommended to use this function.

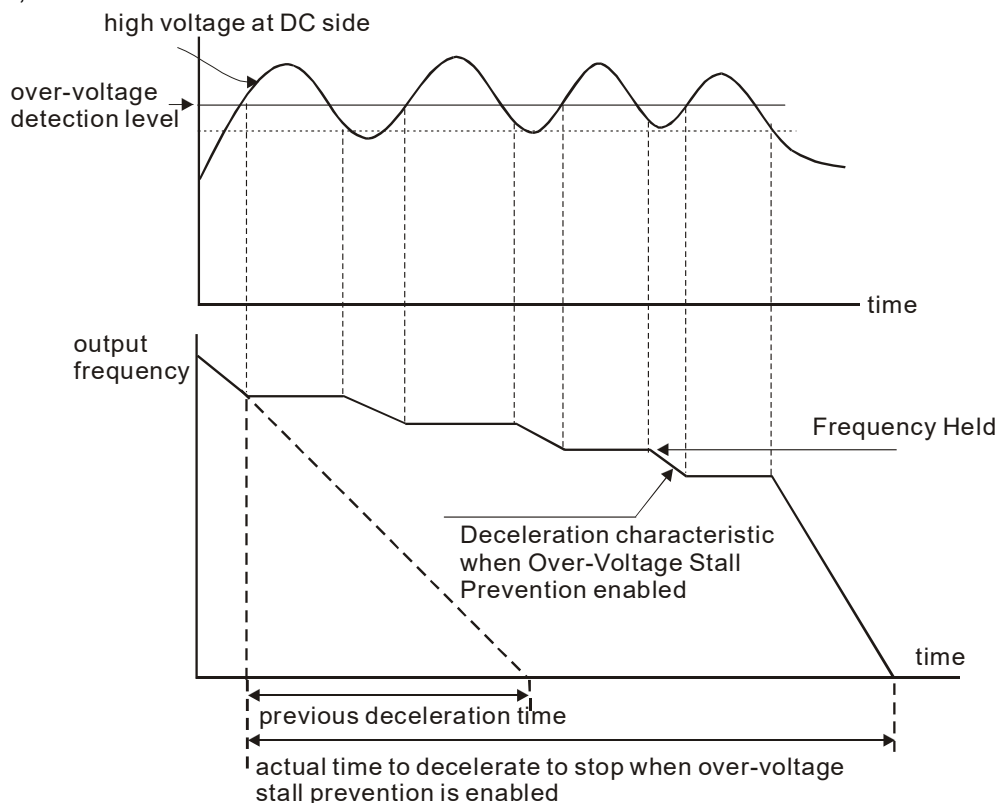

06.01	✎ Over-Current Stall Prevention during Acceleration		Unit: 1
Settings	20–250%		Default: 170
	0: Disable		

- 📖 A setting of 100% is equal to the AC motor drive's Rated Output Current.
- 📖 During acceleration, the AC motor drive output current may increase abruptly and exceed the value specified in Pr.06.01 due to rapid acceleration or excessive load on the motor. When this function is enabled, the AC motor drive stops accelerating and keeps the output frequency constant until the current drops below this setting.

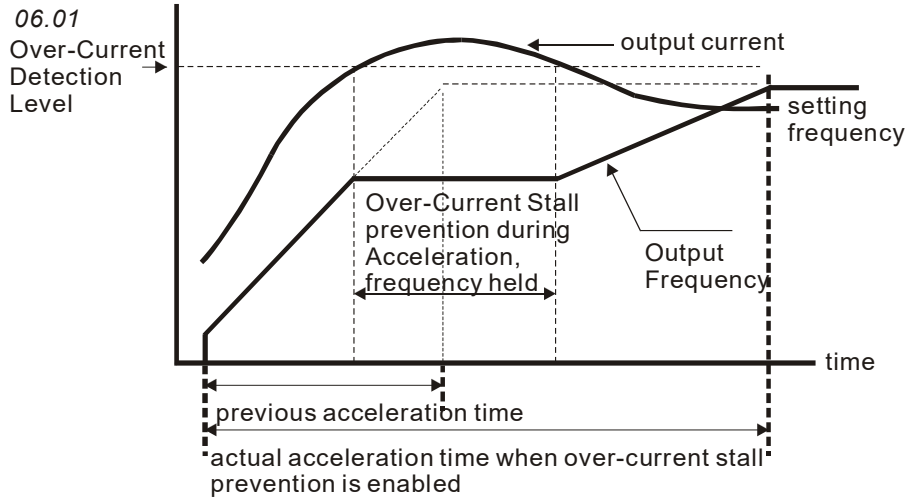

06.02	Over-current Stall Prevention during Operation	Unit: 1
Settings	20–250% 0: Disable	Default: 170

If the output current exceeds the setting for Pr.06.02 when the drive is operating, the drive decreases its output frequency to prevent motor stall. If the output current is lower than the setting for Pr.06.02, the drive accelerates again to catch up with the set frequency command value.

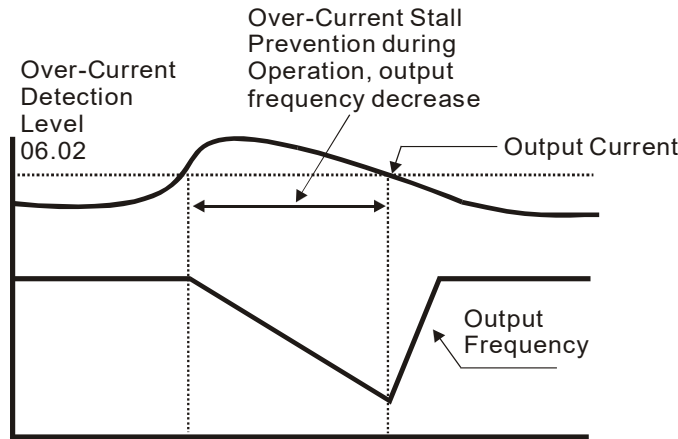

over-current stall prevention during operation

06.03	Over-torque Detection Mode (OL2)	Default: 0
Settings	<p>0 Over-torque detection disabled.</p> <p>1 Over-torque detection enabled during constant speed operation. After over-torque is detected, keep running until OL1 or OL occurs.</p> <p>2 Over-torque detection enabled during constant speed operation. After over-torque is detected, stop running.</p> <p>3 Over-torque detection enabled during acceleration. After over-torque is detected, keep running until OL1 occurs.</p> <p>4 Over-torque detection enabled during acceleration. After over-torque is detected, stop running.</p>	

- Determines the operation mode of the drive after detecting over-torque (OL2). It uses the following methods:
1. If the output current exceeds the Over-torque Detection Level (Pr.06.04) and the detection time is longer than the setting for Pr.06.05 (Over-torque Detection Time), the warning message "OL2" displays.
 2. If a multi-functional output terminal is set to over-torque detection (Pr.03.00=4), the output is ON. Refer to Pr.03.00 for details.

06.04	Over-torque Detection Level	Unit: 1
Settings	10–200%	Default: 150

 This setting is proportional to the Rated Output Current of the drive.

06.05	Over-torque Detection Time	Unit: 0.1
Settings	0.1–60.0 sec.	Default: 0.1

 Sets the length of time that over-torque must be detected before “OL2” displays.

 Over-torque is detected when the following occurs:

1. The output current exceeds the Over-torque Detection Level (Pr.06.04).
 2. The over-torque time exceeds the Over-torque Detection Time (Pr.06.05).
- If a multi-function output terminal is set to over-torque detection (Pr.03.00=4) , the contact is “closed”. Refer to Pr.03.00 for details.

06.06	Electronic Thermal Overload Relay Selection (OL1)	Default: 2
--------------	--	------------

Settings	0	Standard Motor (self-cooled by fan)
	1	Special Motor (forced external cooling)
	2	Disable

 Sets the operation of the electronic thermal overload relay that protects the motor from overloading or overheating. When the motor (self-cooled by fan) operates in low frequency, overloads rarely happen. Refer to the following figures.

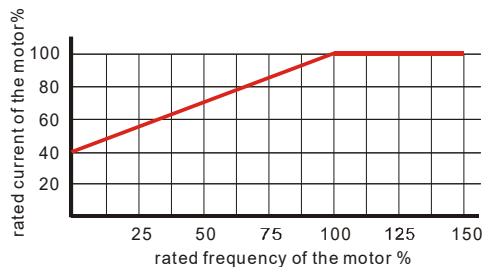

Standard motor
(self-cooled by fan)

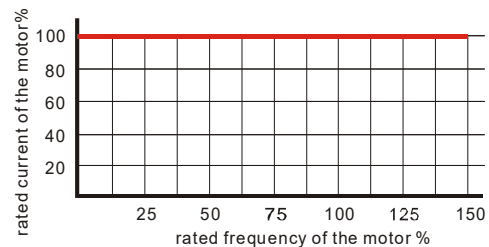

Special Motor
(forced external cooling)

06.07	Electronic Thermal Characteristic	Unit: 1
Settings	30–600 sec	Default: 60

 Determines the time required to activate the I²t electronic thermal protection function. The figure below shows I²t curves for 150% output power for one minute.

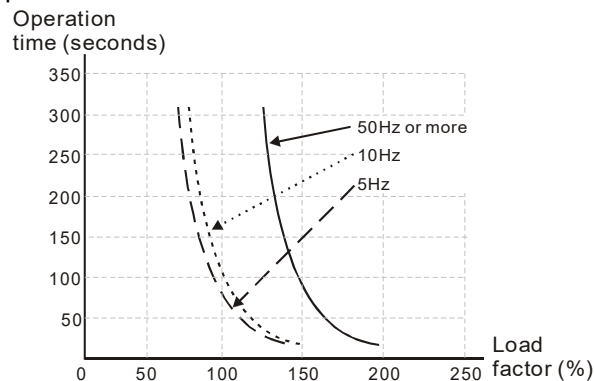

06.08	Present Fault Record	
06.09	Second Most Recent Fault Record	
06.10	Third Most Recent Fault Record	
06.11	Fourth Most Recent Fault Record	
06.12	Fifth Most Recent Fault Record	
Display	0–40	Default: 0

Readings	0	No fault
	1	Over-current (oc)
	2	Over-voltage (ov)

3	IGBT overheat (oH1)
4	Reserved
5	Overload (oL)
6	Overload (oL1)
7	Motor overload (oL2)
8	External Fault (E.F.)
9	Current exceeds two times the rated current during acceleration (ocA)
10	Current exceeds two times the rated current during deceleration (ocd)
11	Current exceeds two times the rated current during constant speed operation (ocn)
12	Reserved
13	Reserved
14	Phase-loss (PHL)
15	Reserved
16	Auto-acceleration / auto-deceleration failure (CFA)
17	Software/password protection (codE)
18	Power Board CPU WRITE failure (cF1.0)
19	Power Board CPU READ failure (cF2.0)
20	CC, OC Hardware protection failure (HPF1)
21	OV Hardware protection failure (HPF2)
22	Reserved
23	OC Hardware protection failure (HPF4)
24	U-phase error (cF3.0)
25	V-phase error (cF3.1)
26	W-phase error (cF3.2)
27	DC bus error (cF3.3)
28	IGBT Overheat error (cF3.4)
29–31	Reserved
32	Reserved
33	Reserved
34	Motor PTC overheat protection (PtC1)
35	FBE_ERR: PID feedback error (Incorrect feedback signal)
36	dEv: unusual PID feedback deviation
37	OPHL
38–40	Reserved

 Pr.06.08 to Pr.06.12 store the five most recent faults that occurred. After clearing the cause of the faults, use the RESET command to reset the drive.

06.13 Motor Disconnection Detection Time

Unit: 1

Settings 0.1–60.0 sec.

Default: 0.0

0.0: Disable

06.14 Motor Disconnection Detection Current Level

Settings 10–100%

Default: 30

 Use Pr.06.13 with Pr.06.14. When three-phase imbalance occurs among three-phase motors and the imbalance reaches Pr.06.14 setting percentage (the percentage is 100% equal to the AC motor drive's rated current settings in Pr.00.01), and lasts the time set in Pr.06.13, OPHL warning displays and the drive stops to prevent the motor from damage due to the three-phase unbalanced operation.

Group 7: Motor Parameters

✎ You can set this parameter during operation.

07.00	✎ Motor Rated Current	Unit: 0.1
Settings	23% FLA–120% FLA	Default: 100

📖 Use the following formula to calculate the percentage value entered in this parameter:

$$\text{FLA} = (\text{Motor Current} / \text{AC Motor Drive Current}) \times 100\%$$

Motor Current = Motor rated current in A on the motor nameplate

AC Motor Drive Current = Rated current of AC motor drive in A (see Pr.00.01)

07.01	✎ Motor No-load Current	Unit: 0.1
Settings	0% FLA–99% FLA	Default: 40

📖 The rated current of the AC motor drive is equal to 100%. The setting for the motor no-load current affects the slip compensation.

📖 The setting value must be smaller than Pr.07.00 (Motor Rated Current).

07.02	✎ Torque Compensation	Unit: 0.1
Settings	0.0–10.0	Default: 0.0

📖 Sets the AC motor drive to automatically increase voltages to get a higher torque when the AC motor drive is running.

📖 Note that too high a torque compensation can overheat the motor.

07.03	✎ Slip Compensation Gain	Unit: 0.01
Settings	0.00–10.00	Default: 0.00

📖 For an asynchronous motor, increasing the load on the AC motor drive causes slip to increase and results in decreased speed. Use this parameter to compensate for slip by increasing the output frequency. When the output current of the AC motor drive is larger than the motor no-load current value (Pr.07.01), the AC motor drive adjusts the output frequency according to this parameter.

07.04	✎ Motor Parameter Auto-Tuning	Default: 0
Settings	0: Disable 1: Auto-tuning R1 (Motor does not run) 2: Auto-tuning R1 + No-load current (with running motor)	

📖 Start auto-tuning by pressing the RUN key after you set this parameter to 1 or 2.

1: Auto-detect only the R1 value, and manually enter Pr.07.01.

2: Unload the AC motor drive and automatically set the values for Pr.07.01 and Pr.07.05.

The steps for auto-tuning are:

1. Ensure that all the parameters are set to defaults and the motor wiring is correctly.
2. Ensure that the motor is not loaded before executing auto-tuning and that the shaft is not connected to any belt or reducer.
3. Enter the correct settings for Pr.01.01 Motor Rated Frequency (Fbase), Pr.01.02 Motor Rated Voltage (Vbase), Pr.07.00 Motor Rated Current, and Pr.07.06 Motor Rated Slip (Motor 0).
4. After you set Pr.07.04 to 2, the AC motor drive executes auto-tuning immediately after receiving a RUN command (CAUTION: the motor will run!). The total auto-tuning time is 15 seconds = Pr.01.09 + Pr.01.10. Higher-power drives need longer acceleration and deceleration time (the default is recommended). After executing auto-tuning, it sets Pr.07.04 to 0.
5. After executing auto-tuning, check to ensure there are values filled in for Pr.07.01 and Pr.07.05. If not, press the RUN key after setting Pr.07.04 again to repeat auto-tuning.
6. Finally, set Pr.00.10 to 1 and set other parameters according to your application requirements.
 - Related parameters: Pr.01.01 Motor Rated Frequency (Fbase); Pr.01.02 Motor Rated Voltage (Vbase); Pr.07.00 Motor Rated Current; Pr.07.01 Motor No-Load Current; Pr.07.05 Motor Line-to Line Resistance R1 (Motor 0); Pr.07.06 Motor Rated Slip (Motor 0).

 **NOTE**

1. In vector control mode, it is not recommended to have motors run in parallel.

2. Vector control mode is not recommended if the motor rated power exceeds the rated power of the AC motor drive.

07.05	Motor Line-to-line Resistance R1 (Motor 0)		
	Settings	0–65535 mΩ	Default: 0

 The motor auto-tuning procedure sets this parameter. You can also set this parameter without using Pr.07.04 (Motor Parameter Auto-Tuning). This resistance value is the R value between phase and phase of the motor. Regardless of the motor wiring method, this resistance value is the measured value of any two motor leads.

07.06	Motor Rated Slip (Motor 0)		
	Settings	0.00–20.00 Hz	Default: 3.00

 Sets the motor rated slip. Enter the actual rated RPM from the motor nameplate.

 Refer to the rated RPM and the number of poles from the motor nameplate and use the following equation to calculate the rated slip:

$$\text{Rated Slip} = F - N \times P / 120$$

F: Rated frequency (Hz)

N: Rated speed (RPM)

P: Number of poles (Pole)

Assume that the rated frequency of the motor is 60 Hz with 4 poles, and the rated RPM is 1650. The rated slip calculated by the formula is $60 \text{ Hz} - (1650 \text{ rpm} \times 4 / 120) = 5 \text{ Hz}$.

 This parameter is related to Pr.07.03 Slip Compensation Gain. To get the best slip compensation effect, you must enter the correct settings. The incorrect setting may cause invalid slip compensation and even damage the motor and the AC motor drive.

➤ Related parameter: Pr.07.03 Slip Compensation Gain

07.07	Slip Compensation Limit		
	Settings	0–250%	Default: 200

 This parameter sets the upper limit of the compensation frequency (the percentage of Pr.07.06). If the motor speed is lower than the target speed and the speed does not change after adjusting the Pr.07.03 setting, the AC motor drive may reach the upper limit of the compensation frequency and you may need to increase the Pr.07.07 setting.

➤ Related parameters: Pr.07.03 Slip Compensation Gain, Pr.07.06 Motor Rated Slip (Motor 0).

07.08	Torque Compensation Time Constant		
	Settings	0.01–10.00 sec.	Default: 0.10

 This function is usually applied in applications with heavy load where the motor current changes frequently for the current compensation to increase the output torque. The frequent current change can cause machine vibration. Increase the Pr.07.08 setting to solve this problem.

07.09	Slip compensation Time Constant		
	Settings	0.05–10.00 sec.	Default: 0.20

 This function is usually applied in applications with heavy load where the motor speed changes frequently for the speed compensation to reach the synchronous speed. The frequent speed change can cause machine vibration. Increase the Pr.07.09 setting to solve this problem.

 Setting the time constants too high (set Pr.07.08 and Pr.07.09 to 10) results in slow response; setting them too low results in unstable operation.

07.10	Accumulated Motor Operation Time (Minute)		Unit: 1
	Settings	0–1439	Default: 0

07.11	Accumulated Motor Operation Time (Day)		Unit: 1
	Settings	0–65535	Default: 0

 Pr.07.10 and Pr.07.11 record the motor operation time. Clear the values by setting them to 0. Any time that is less than one minute is not recorded.

07.12	Motor PTC Overheat Protection	Unit: 1
		Default: 0
Settings	0 Disable	
	1 Enable	
07.14	Motor PTC Overheat Protection Level	Unit: 0.1
Settings	0.1–10.0 V	Default: 2.4

- 📖 Running the motor at low frequency for a long time reduces the cooling function of the motor fan. To prevent overheating, use a Positive Temperature Coefficient thermistor on the motor, and connect the thermistor output signal to the drive's corresponding control terminals.
- 📖 When you set the source of the first and second frequency command to AVI (Pr.02.00=1 / Pr.02.09=1), you disable the motor PTC overheat protection (that is, Pr.07.12 cannot be set to 1).
- 📖 If the temperature exceeds the setting level, the motor coasts to stop and PtC1 (P t C 1) displays. When the temperature decreases below the level of (Pr.07.15 minus Pr.07.16) and P t C 1 stops blinking, you can press the RESET key to clear the fault.
- 📖 Pr.07.14 (overheat protection level) must be greater than Pr.07.15 (overheat warning level).
- 📖 The PTC function uses the AVI-input and is connected with a resistor-divider as shown in the diagram below.
 1. The voltage between +10 V to ACM: between 10.4–11.2 V.
 2. The impedance for AVI is around 47 kΩ.
 3. The recommended value for the resistor-divider R1 is 1–10 kΩ.
 4. Please contact your motor dealer for the temperature curve and resistance value for the PTC function.

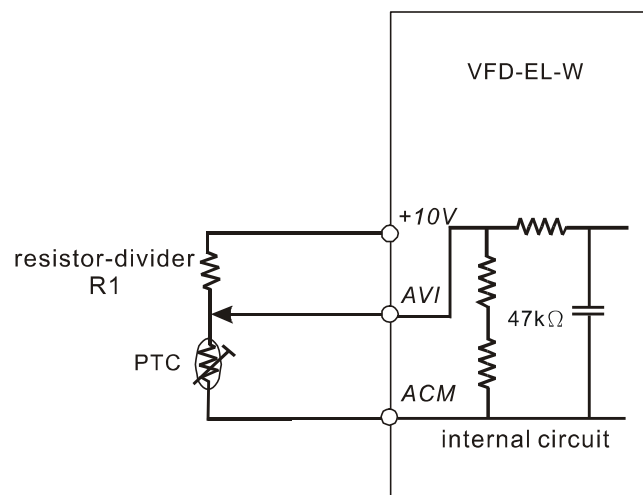

- 📖 Refer to the following calculation for the protection and warning levels.
 1. Protection level

$$\text{Pr.07.14} = V_{+10} * (R_{\text{PTC1}} // 47\text{k}) / [R1 + (R_{\text{PTC1}} // 47\text{k})]$$
 2. Warning level

$$\text{Pr.07.15} = V_{+10} * (R_{\text{PTC2}} // 47\text{k}) / [R1 + (R_{\text{PTC2}} // 47\text{k})]$$
 3. Definition:
 V+10: voltage between +10 V to ACM, Range 10.4–11.2 V
 R_{PTC1}: motor PTC overheat protection level; set the corresponding voltage level in Pr.07.14
 R_{PTC2}: motor PTC overheat warning level; set the corresponding voltage level in Pr.07.15
 47 kΩ: the AVI input impedance
 R1: resistor-divider (recommended value: 1–10 kΩ)
- 📖 Example: using a standard PTC thermistor, if the protection level is 1330 Ω, the voltage between +10 V to ACM is 10.5 V and resistor-divider R1 is 4.4 kΩ. Refer to the following calculation for the Pr.07.14 setting.

$$1330 // 47000 = (1330 * 47000) / (1330 + 47000) = 1293.4$$

$$10.5 * 1293.4 / (4400 + 1293.4) = 2.38(\text{V}) \approx 2.4(\text{V})$$
 Therefore, set Pr.07.14 to 2.4.

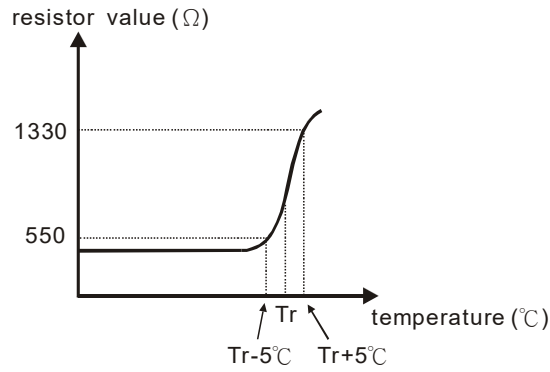

07.15	Motor PTC Overheat Warning Level	Unit: 0.1
Settings	0.1–10.0 V	Default: 1.2
07.16	Motor PTC Overheat Reset Delta Level	Unit: 0.1
Settings	0.1–5.0 V	Default: 0.6
07.17	Motor PTC Overheat Action	Default: 0
Settings	0 Warn and ramp to stop	
	1 Warn and coast to stop	
	2 Warn and keep operating	

If the temperature exceeds the motor PTC Overheat Warning Level (Pr.07.15), the drive acts according to Pr.07.17 and displays PtC2 (PtC2) on the digital keypad. If the temperature decreases below the result of (Pr.07.15 minus Pr.07.16), the warning message disappears.

07.13	Motor PTC Protection Input Response Time	Unit: 1
Settings	0–9999 (*2 ms)	Default: 100

Group 8: Special Parameters

✎ You can set this parameter during operation.

08.00	DC Brake Current Level	Unit: 1
Settings	0–100%	Default: 0

- ☞ Sets the level of the DC Brake Current output to the motor during start-up and stopping. When setting the DC Brake Current, the AC Motor Drive Rated Current (Pr.00.01) is equal to 100%. It is recommended to start with a low DC Brake Current Level and then increase it until you reach the proper holding torque.

08.01	DC Brake Time during Start-up	Unit: 0.1
Settings	0.0–60.0 sec.	Default: 0.0

- ☞ Determines the duration of the DC Brake current after a RUN command. When the time has elapsed, the AC motor drive starts accelerating from the Minimum Output Frequency (Pr.01.05).

08.02	DC Brake Time during Stopping	Unit: 0.1
Settings	0.0–60.0 sec.	Default: 0.0

- ☞ Determines the duration of the DC Brake current during stopping. If you want to stop the motor with the DC Brake, set Pr.02.02 (Stop Method) to 0 or 2 for Ramp to Stop.

08.03	Start-point for DC Brake	Unit: 0.01
Settings	0.00–400.00 Hz	Default: 0.00

- ☞ Determines the frequency at which the DC Brake is applied during deceleration.

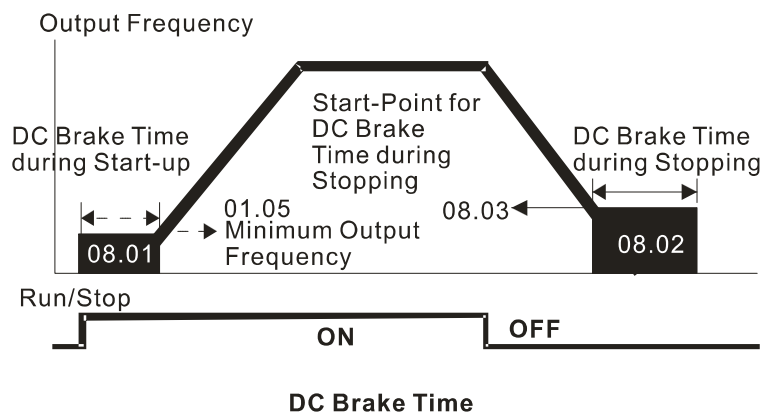

- ☞ Use the DC Brake during Start-up for loads that may move before the AC drive starts, such as fans and pumps. The DC Brake can hold the load in position before starting the motor.
- ☞ Use the DC Brake during stopping to shorten the stopping time, and to hold a stopped load in position, such as cranes and cutting machines.

08.04	Momentary Power Loss Action	Default: 0
Settings	0 Operation stops (coast to stop) after momentary power loss.	
	1 Operation continues after momentary power loss, speed search starts with the last frequency.	
	2 Operation continues after momentary power loss, speed search starts with the minimum frequency.	

- ☞ Determines the operation mode when the AC motor drive restarts from a momentary power loss.

08.05	Maximum Allowable Power Loss Time	Unit: 0.1
Settings	0.1–20.0 sec.	Default: 2.0

- ☞ Sets the maximum allowable power loss time. If the time exceeds the Maximum Allowable Power Loss Time, the AC motor drive output turns off (coast to stop).

The selected operation after power loss in Pr.08.04 is only executed when the maximum allowable power loss time is ≤ 5 seconds and the AC motor drive keypad displays “Lu”.
 If the AC motor drive is powered off due to overload, even if the maximum allowable power loss time is ≤ 5 seconds, the drive does not execute the operation mode you set for Pr.08.04. In that case it starts up normally.

08.06 Base Block Speed Search Default: 1

Settings	0	Disable
	1	Speed search starts with the last frequency command
	2	Speed search starts with the minimum output frequency (Pr.01.05)

Determines the AC motor drive restart method after an External Base Block is enabled.

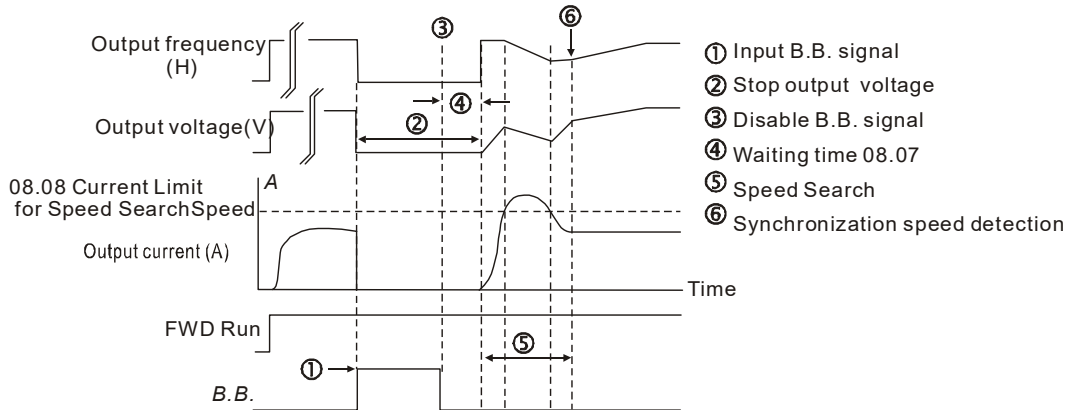

Fig 1: B.B. Speed Search with Last Output Frequency Downward Timing Chart (Speed Search Current Attains Speed Search Level)

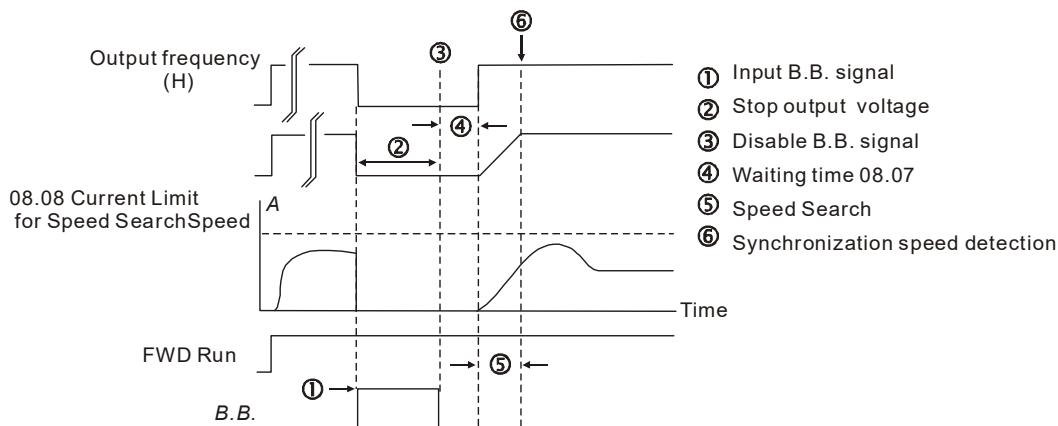

Fig 2: B.B. Speed Search with Last Output Frequency Downward Timing Chart (Speed Search Current doesn't Attain Speed Search Level)

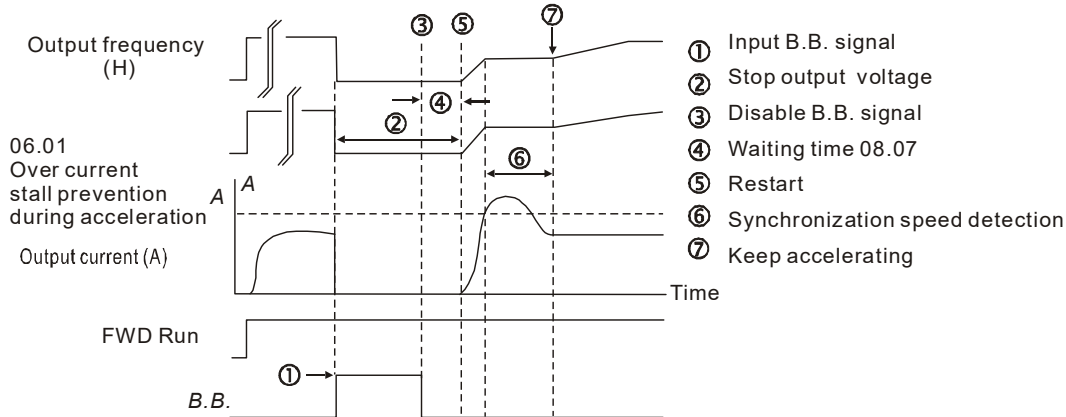



Fig3: B.B. Speed Search with Minimum Output Frequency Upward Timing Chart



08.07 Base Block Time for Speed Search (B.B.) Unit: 0.1

Settings	0.1–5.0 sec.	Default: 0.5
----------	--------------	--------------

-  When the AC motor drive detects a momentary power loss, it blocks its output and then waits for a period of time specified by this parameter before resuming operation. Set this parameter at a value that ensures that any residual regeneration voltage from the motor on the output has disappeared before the drive is activated again.
-  This parameter also determines the waiting time before resuming operation after an External Base Block and Number of Auto-restarts after Fault (Pr.08.15).

08.08	Current Limit for Speed Search	Unit: 1
--------------	--------------------------------	---------

Settings	30–200%	Default: 150
----------	---------	--------------

-  Limits the drive output current during a speed search.
-  When executing a speed search, the V/F curve is defined by the settings in Parameter Group 01.

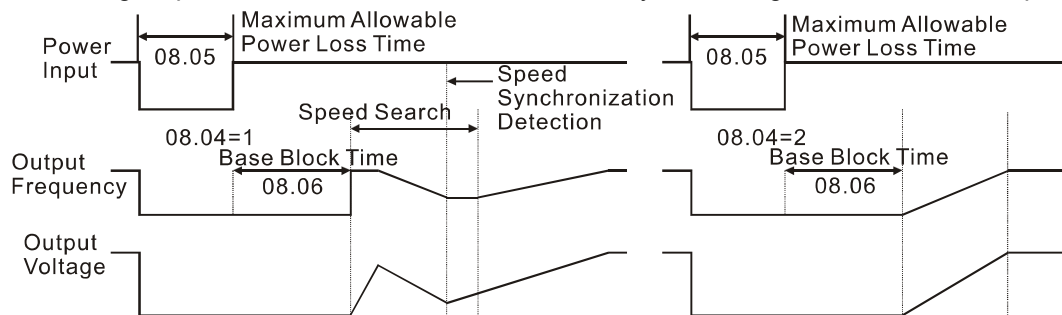

Momentary Power Loss Operation

08.09	Skip Frequency 1 Upper Limit	Unit: 0.01
--------------	------------------------------	------------

08.10	Skip Frequency 1 Lower Limit	Unit: 0.01
--------------	------------------------------	------------

08.11	Skip Frequency 2 Upper Limit	Unit: 0.01
--------------	------------------------------	------------

08.12	Skip Frequency 2 Lower Limit	Unit: 0.01
--------------	------------------------------	------------

08.13	Skip Frequency 3 Upper Limit	Unit: 0.01
--------------	------------------------------	------------

08.14	Skip Frequency 3 Lower Limit	Unit: 0.01
--------------	------------------------------	------------

Settings	0.00–400.00 Hz	Default: 0.00
----------	----------------	---------------

-  These parameters cause the AC motor drive not to remain in these frequency ranges with continuous frequency output. Set these six parameters as follows $\text{Pr.08.09} \geq \text{Pr.08.10} \geq \text{Pr.08.11} \geq \text{Pr.08.12} \geq \text{Pr.08.13} \geq \text{Pr.08.14}$.

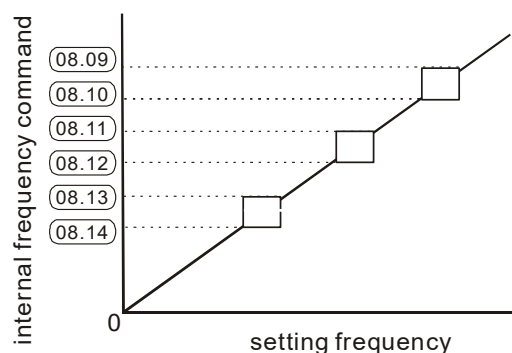



08.15	Number of Auto-restarts After Fault	Unit: 1
--------------	-------------------------------------	---------

Settings	0–10	Default: 0
----------	------	------------

08.16	Auto-reset Time for Restart after Fault	Unit: 0.1
--------------	---	-----------

Settings	0.1–6000 sec.	Default: 60.0
----------	---------------	---------------

-  After an over-current OC or over-voltage OV fault occurs, the AC motor drive can automatically reset/restart up to ten times.
-  Setting this parameter to 0 disables automatic reset/restart operation after any fault. When enabled, the AC motor drive restarts with speed search, which starts at the last frequency before the fault.

Use this parameter in conjunction with Pr.08.15.
 For example: If you set Pr.08.15 to 10 and Pr.08.16 to 600 seconds (10 minutes), and if there is no fault for over 600 seconds from the restart for the previous fault, then the number of auto-restarts after a fault is reset to 10.

08.17 Auto-energy Saving Default: 0

Settings	0	Disable Energy-saving operation
	1	Enable Energy-saving operation

When you set Pr.08.17 to 1, acceleration and deceleration operate at full voltage. During constant speed operation, the AC motor drive automatically calculates the best voltage value for the power for the current load. This function is not suitable for constantly changing loads or near-full loads during operation.

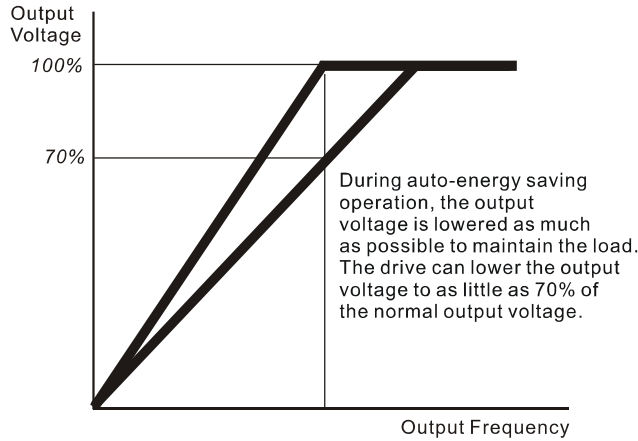

08.18 Automatic Voltage Regulation (AVR) Default: 0

Settings	0	AVR function enabled
	1	AVR function disabled
	2	AVR function disabled for deceleration
	3	AVR function disabled for stop

The motor rated voltage is usually 230/200 V_{AC} 50/60 Hz and the AC motor drive input voltage may vary between 180–264 V_{AC} 50/60 Hz. Therefore, when you use the AC motor drive without the AVR function, the output voltage is the same as the input voltage. When the motor runs at voltages exceeding the rated voltage by 12–20%, the motor's lifetime is shortened and the motor can be damaged due to higher temperature, failing insulation and unstable torque output.

The AVR function automatically regulates the AC motor drive output voltage to the Maximum Output Voltage (Pr.01.02). For instance, if you set Pr.01.02 to 200 V_{AC} and the input voltage is at 200–264 V_{AC}, then the Maximum Output Voltage is automatically reduced to a maximum of 200 V_{AC}.

When the motor ramps to stop, the deceleration time is longer. When setting this parameter to 2 with auto-acceleration / auto-deceleration, the deceleration is quicker.

08.19 Reserved

08.20 Compensation Coefficient for Motor Instability Unit: 0.1

Settings	0.0–5.0	Default: 0.0
----------	---------	--------------

The drift current occurs in a specific zone of the motor and it causes serious motor vibration. It is recommended to use this parameter (the recommended value is 2.0) to greatly improve this situation. (The drift current zone for high-power motors is usually in the low frequency area.)

08.21 DC Current Level during Preheating Default: 0

Settings	0–100%	Default: 0
----------	--------	------------

- 📖 Sets the DC current level input to the motor during preheating. The DC current during preheating is 100% equal to the Motor Rated Current (Pr.07.00). When setting this parameter, increase the current level slowly until you reach the desired preheating temperature.
- 📖 Related parameters: Pr.08.22 (DC Current Cycle Time during Preheating), Pr.03.00 (Multi-function Output Relay #24: Preheating function indication), Pr.04.06–Pr.04.08 (Multi-function Input Terminal #26: Auto-trigger preheating function).

08.22 DC Current Cycle Time during Preheating

Settings

0–100%

Default: 0

- 📖 Sets the cycle time that the DC current input to the motor during preheating. 0–100% corresponds to 0–10 seconds. When you set the cycle time to 0%, it means that there is no current output; 100% means continuous current output. For example, if you set the cycle time to 50%, the time that the current input to the motor for one cycle is five seconds; the stopping time is five seconds. When the AC motor drive stops running, continuous DC current automatically and cyclically input to the motor. When you use this parameter with MI=26 (Auto-trigger preheating function), this parameter works with the MI signal continuously and cyclically until the AC motor drive starts the motor operation or MI=26 is disabled.
- 📖 The preheating function works when Pr.08.21 and Pr.08.22 are not set to 0.
- 📖 When MI=26 (Auto-trigger preheating function) is enabled, MI terminal determines the preheating function.
- 📖 When MI=26 is disabled, the preheating function is enabled after the AC motor drive stops its first operation or when the AC motor drive starts after re-applying power.
- 📖 The diagram below shows the 50% setting for the cycle time that the DC current input to the motor during preheating when MI=26 (Auto-trigger preheating function) is enabled.

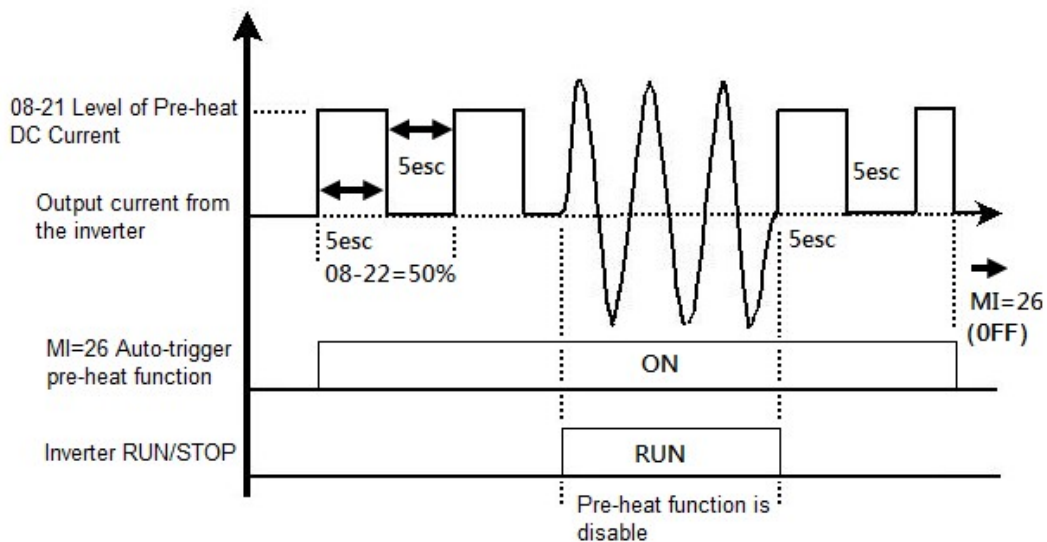

- 📖 The diagram below shows the 50% setting for the cycle time that the DC current input to the motor during preheating when MI=26 (Auto-trigger preheating function) is disabled. The preheating function automatically enables continuous current input after the drive stops running.

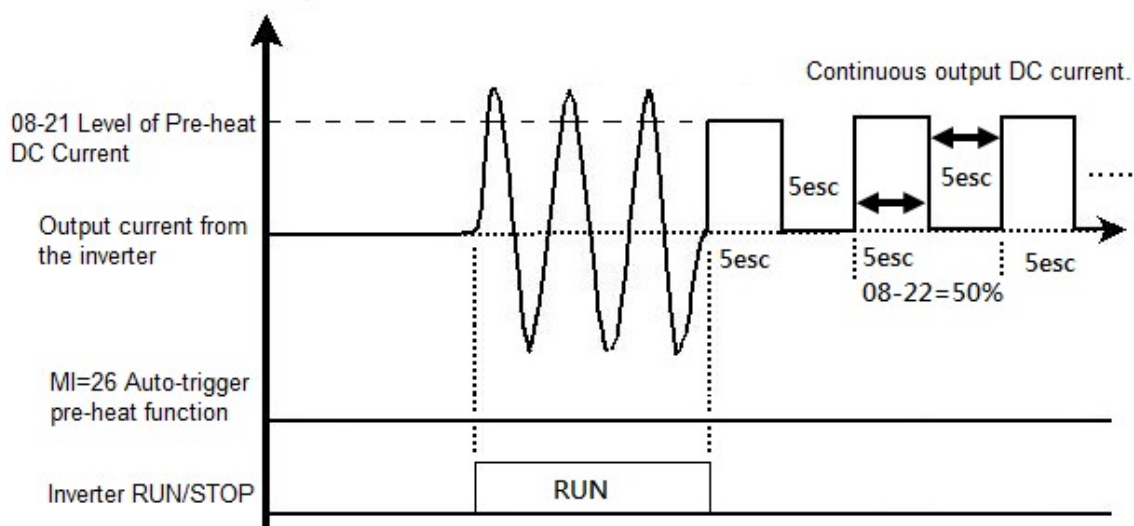

The diagram below shows the sequential relationship between the preheating function and enabled DC brake.

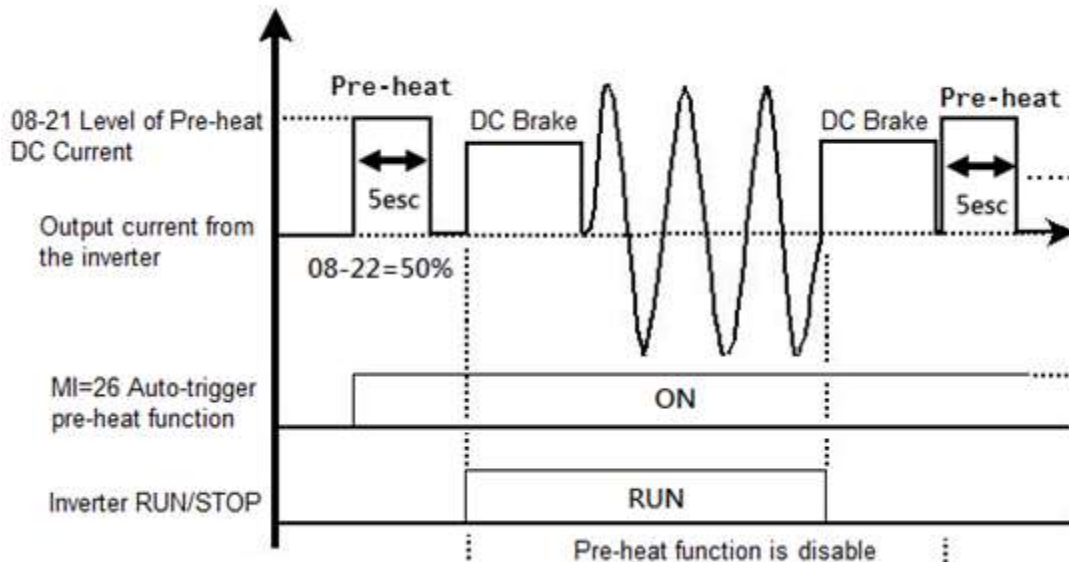

08.23 Fire Mode

Settings	0: No function 1: Forward running 2: Running in reverse	Default: 0
----------	---	------------

Use this parameter with Pr.04.06–Pr.04.08 multi-function input terminals #27 or #28 (Fire mode enabled with/without operation command) and Pr.03.00 multi-function output terminal #25 (Fire Mode Indication).

- 0: The fire mode is invalid.
- 1: The motor runs in a clockwise direction (U, V, W) during fire accident.
- 2: The motor runs in a counterclockwise direction (U, V, W) during fire accident.

08.24 Operating Frequency during Fire Mode

Settings	0.00–400.00 Hz	Default: 60.00
----------	----------------	----------------

Sets the AC motor drive's operating frequency when the fire mode is enabled.

08.25 Number of Fire Mode Actions

Settings	Read only	Default: Read only
----------	-----------	--------------------

As long as the fire mode is enabled for more than four minutes, regardless of whether the AC motor drive runs or not, the fire mode action and its number of occurrences are recorded. Note that this parameter is read-only. Any parameter value that is not zero voids the warranty.

※ Fire mode end process flow:

If you set the Pr.04.06–Pr.04.08 multi-function input terminal=27/28 to ON or the communication address to 2002H with bit5=1 (fire mode enabled), and the fire mode is enabled for more than four minutes, and then you set the Pr.04.06–Pr.04.08 multi-function input terminal=27/28 to OFF or the communication address to 2002H with bit5=0 (no function), the counter starts to count from four minutes after the fire mode is enabled. After the fire mode is enabled for 2.5 hours, the AC motor drive resumes normal operation, and stops or operates to normal operating frequency according to the original input status.

If you set the Pr.04.06–Pr.04.08 multi-function input terminal=27/28 to ON or the communication address to 2002H with bit5=1 (fire mode enabled), and the fire mode is enabled for less than four minutes, the AC motor drive resumes normal operation once the fire mode is disabled, and stops or operates to normal operating frequency according to the original input status.

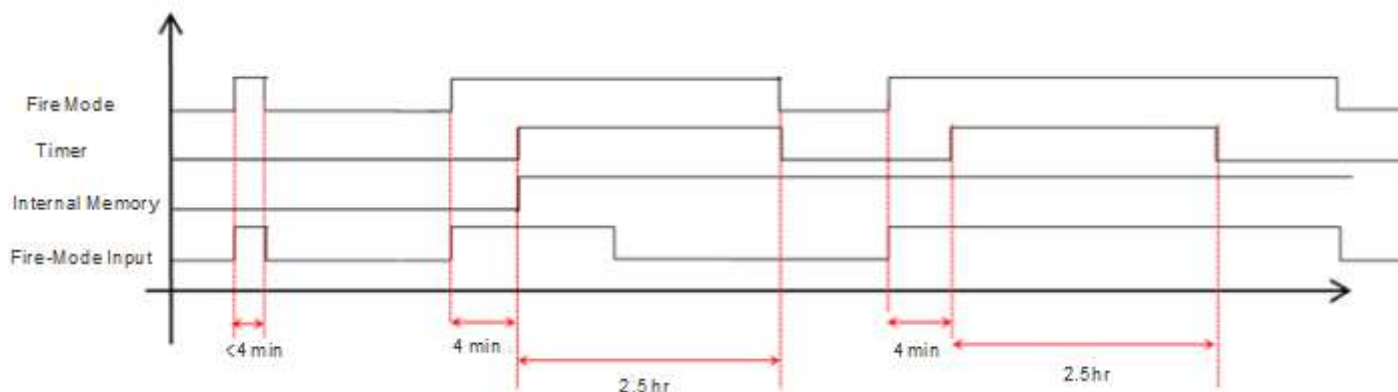

※ Fault code list of normal mode and fire mode:

No.	Fault Name	Normal Mode	Fire Mode
1	Over current (oc)	√	√
2	Over voltage (ov)	√	√
3	Over heat 1 (oH1)	√	No detection
4	Over heat 2 (oH2)	√	No detection
5	Over Load (oL) (150% 1 Min., Drive)	√	No detection
6	Internal electronic overload trip (oL1)	√	No detection
7	Motor over load (oL2)	√	No detection
8	External fault (EF)	√	√
9	Over current during Acceleration (ocA)	√	√
10	Over current during Deceleration (ocD)	√	√
11	Over current during normal speed (ocN)	√	√
12	Reserved		
13	Low voltage (LV)	√	√
14	Input phase loss (PHL)	√	√
15	base block (bb)	√	√
16	Auto acceleration/deceleration failure (cFA)	√	√
17	Software parameter protection failure (code)	√	√
18	Internal EE parameter OM cannot write (cF10)	√	√
19	Internal EE parameter OM cannot read (cF20)	√	√
20	Hardware NMI (HPF1)	√	√
21	Hardware OV (HPF2)	√	√
22	Reserved		
23	Hardware OC (HPF4)	√	√
24	Hardware IU (CF3.0)	√	√
25	Hardware IV (CF3.1)	√	√
26	Hardware IW (CF3.2)	√	√
27	Hardware DC bus (CF3.3)	√	√
28	Hardware Temperature (CF3.4)	√	No detection
32	Analog signal Error (AErr)	√	√
34	Motor overheat parameter protect (PTC)	√	√
35	Analog feedback error (FBE)	√	√
36	Deviation error (DEV)	√	√

Group 9: Communication Parameters

✎ You can set this parameter during operation.

The AC motor drive includes a built-in RS-485 serial interface, marked RJ45 near the control terminals. The RS-485 pins are defined below.

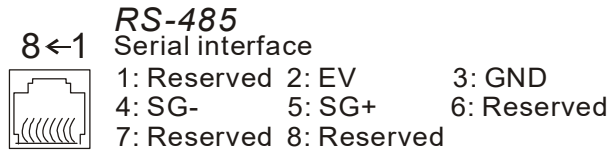

09.00	✎ Communication Address	Default: 1
Settings	1–254	

📖 You must set the communication address this drive if the AC motor drive is controlled by RS-485 serial communication. The communication address for each AC motor drive must be unique.

09.01	✎ Transmission Speed	Default: 1
--------------	-----------------------------	------------

- | | | |
|----------|----|-------------------------------------|
| Settings | 0: | Baud rate 4800 bps (bits / second) |
| | 1: | Baud rate 9600 bps (bits / second) |
| | 2: | Baud rate 19200 bps (bits / second) |
| | 3: | Baud rate 38400 bps (bits / second) |

📖 Sets the transmission speed between the RS-485 master (such as PC) and the AC motor drive.

09.02	✎ Transmission Fault Action	Default: 3
--------------	------------------------------------	------------

- | | | |
|----------|----|-------------------------------|
| Settings | 0: | Warn and keep operating |
| | 1: | Warn and ramp to stop |
| | 2: | Warn and coast to stop |
| | 3: | No warning and keep operating |

📖 Determines how the AC motor drive reacts if a transmission fault occurs.

09.03	✎ Time-out Detection	Unit: 0.1
Settings	0.0–120.0 sec.	Default: 0.0
	0.0 Disable	

📖 If Pr.09.03 is not equal to 0.0, and Pr.09.02=0–2, and there is no communication on the bus during the time-out detection period (set by Pr.09.03), the digital keypad displays “cE10”.

09.04	✎ Communication Protocol	Default: 0
--------------	---------------------------------	------------

- | | | |
|----------|-----|---------------------------------------|
| Settings | 0: | Modbus ASCII mode, protocol <7, N, 2> |
| | 1: | Modbus ASCII mode, protocol <7, E, 1> |
| | 2: | Modbus ASCII mode, protocol <7, O, 1> |
| | 3: | Modbus RTU mode, protocol <8, N, 2> |
| | 4: | Modbus RTU mode, protocol <8, E, 1> |
| | 5: | Modbus RTU mode, protocol <8, O, 1> |
| | 6: | Modbus RTU mode, protocol <8, N, 1> |
| | 7: | Modbus RTU mode, protocol <8, E, 2> |
| | 8: | Modbus RTU mode, protocol <8, O, 2> |
| | 9: | Modbus ASCII mode, protocol <7, N, 1> |
| | 10: | Modbus ASCII mode, protocol <7, E, 2> |

11: Modbus ASCII mode, protocol <7, O, 2>

Control by PC

- When using RS-485 to connect with the communication port, you must set the communication address for each VFD-EL-W drive in Pr.09.00 first so that the PC controls according to each address.
- You can set a VFD-EL-W drive to communicate over Modbus networks using one of the following modes: ASCII (American Standard Code for Information Interchange) or RTU (Remote Terminal Unit). Select the desired mode along with the serial port communication protocol in this parameter.
- Code Description:
The CPU delays about 1 second when using the communication reset; therefore, there is at least 1 second delay time in the master station.

ASCII mode:

Each 8-bit data is the combination of two ASCII characters. For example, a 1-byte data: 64 Hex, shown as '64' in ASCII, consists of '6' (36Hex) and '4' (34Hex).

Character	'0'	'1'	'2'	'3'	'4'	'5'	'6'	'7'
ASCII code	30H	31H	32H	33H	34H	35H	36H	37H

Character	'8'	'9'	'A'	'B'	'C'	'D'	'E'	'F'
ASCII code	38H	39H	41H	42H	43H	44H	45H	46H

RTU mode:

Each 8-bit data is the combination of two 4-bit hexadecimal characters. For example, 64 Hex.

Data Format

Character Frame for ASCII:

(7, N, 2)

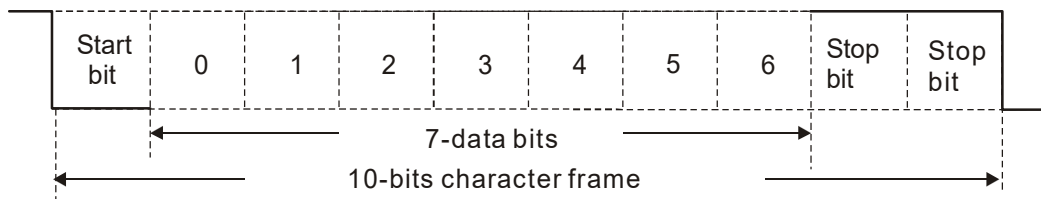

(7, E, 1)

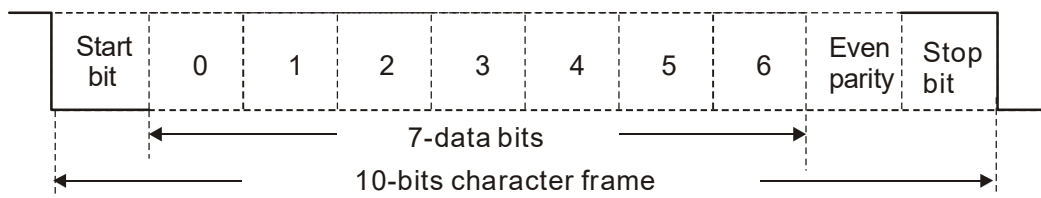

(7, O, 1)

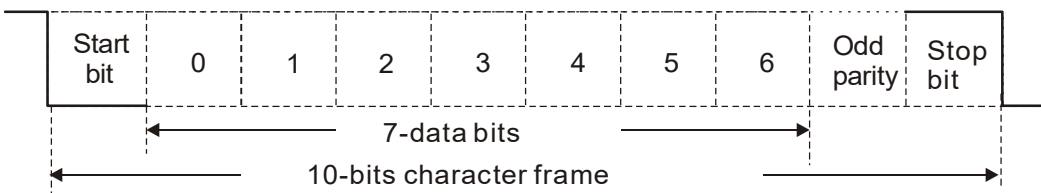

(7, N, 1)

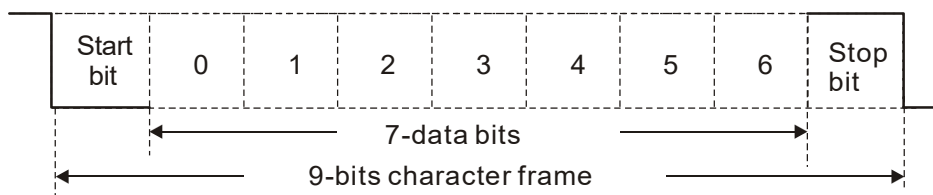

(7, E, 2)

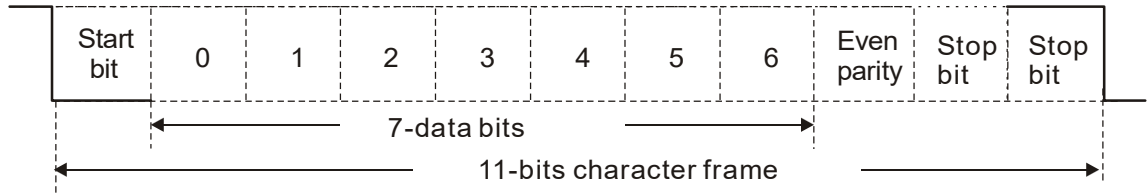

(7, O, 2)

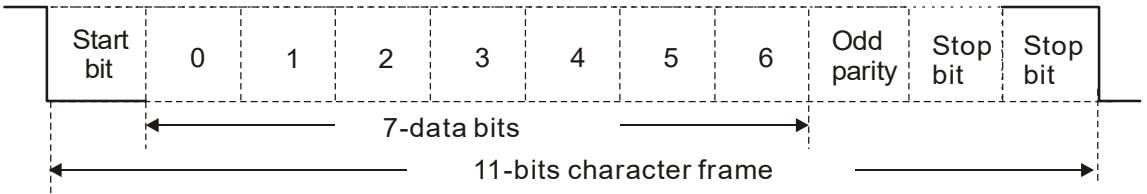

Character Frame for RTU:

(8, N, 2)

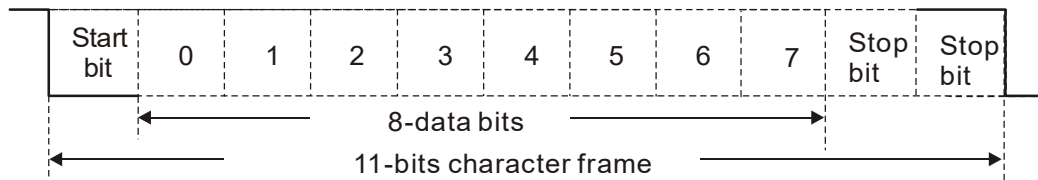

(8, E, 1)

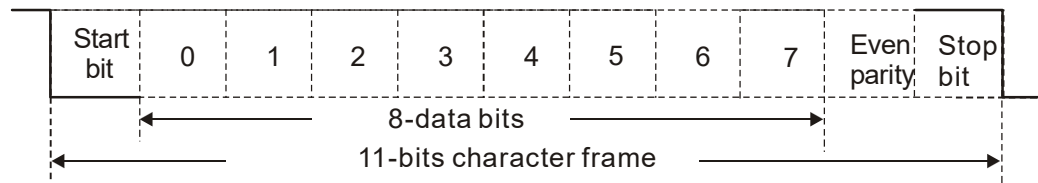

(8, O, 1)

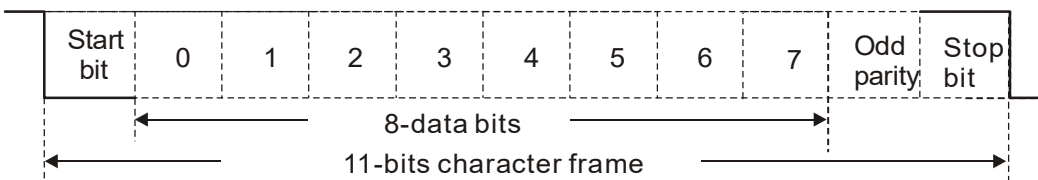

(8, N, 1)

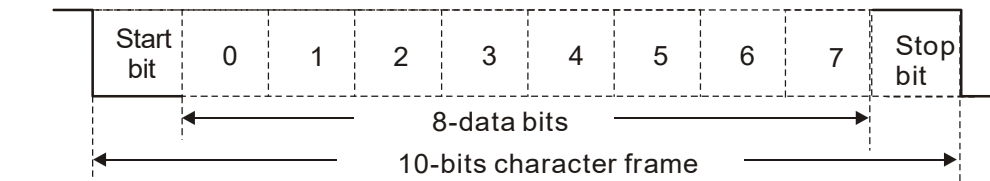

(8, E, 2)

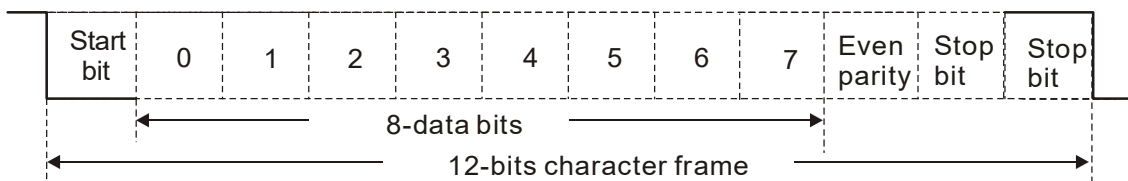

(8, 0, 2)

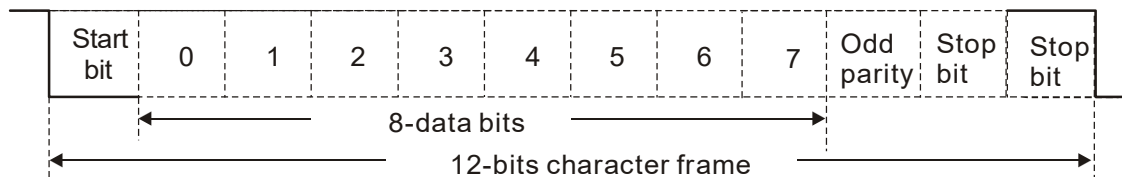

Communication Protocol

1. Communication Data Frame

ASCII mode:

STX	Start character ':' (3AH)
Address Hi	Communication address: 8-bit address consists of two ASCII codes.
Address Lo	
Function Hi	Command code: 8-bit command consists of two ASCII codes.
Function Lo	
DATA (n-1) to DATA 0	Contents of data: Nx8-bit data consists of 2n ASCII codes. n ≤ 20, maximum of 40 ASCII codes.
LRC CHK Hi	LRC checksum: 8-bit checksum consists of two ASCII codes.
LRC CHK Lo	
END Hi	End characters: END1 = CR (0DH), END0 = LF (0AH)
END Lo	

RTU mode:

START	A silent interval of more than 10 ms
Address	Communication address: 8-bit address
Function	Command code: 8-bit command
DATA (n-1) to DATA 0	Contents of data: n×8-bit data, n ≤ 40 (20 x 16-bit data).
CRC CHK Low	CRC checksum: 16-bit checksum consists of two 8-bit characters.
CRC CHK High	
END	A silent interval of more than 10 ms

2. Address (Communication Address)

Valid communication addresses are between 0–254. A communication address of 0 means broadcast to all AC motor drives (AMD). In this case, the AMD broadcast does not reply with any message to the master device.

00H: broadcast to all AC motor drives

01H: AC motor drive with address 01

0FH: AC motor drive with address 15

10H: AC motor drive with address 16

:

FEH: AC motor drive with address 254

For example, send communication to AMD with address 16 decimal (10H):

ASCII mode: Address = '1','0' => '1' = 31H, '0' = 30H

RTU mode: Address = 10H

3. Function (Function code) and DATA (data characters)
 The format of the data characters depends on the function code.
 03H: Read data from register
 06H: Write single register
 08H: Loop detection

The available function codes and examples for the VFD-EL-W drive are described in the following tables.
 (1) 03H: multi-read, read data from registers.
 Example: reading two continuous data from register address 2102H; AMD address is 01H.
 ASCII mode:

Command message:

STX	':'
Address	'0'
	'1'
Function	'0'
	'3'
Starting data address	'2'
	'1'
	'0'
	'2'
Number of data (count by word)	'0'
	'0'
	'0'
	'2'
LRC Check	'D'
	'7'
END	CR
	LF

Response message:

STX	':'
Address	'0'
	'1'
Function	'0'
	'3'
Number of data (Count by byte)	'0'
	'4'
Content of starting address 2102H	'1'
	'7'
	'7'
Content of address 2103H	'0'
	'0'
	'0'
LRC Check	'7'
	'1'
END	CR
	LF

RTU mode:

Command message:

Address	01H
Function	03H
Starting data address	21H
	02H
Number of data (count by word)	00H
	02H
CRC CHK Low	6FH
CRC CHK High	F7H

Response message:

Address	01H
Function	03H
Number of data (count by byte)	04H
Content of address 2102H	17H
	70H
Content of address 2103H	00H
	00H
CRC CHK Low	FEH
CRC CHK High	5CH

(2) 06H: single write, write single data to register.
 Example: writing data 6000 (1770H) to register 0100H; AMD address is 01H.
 ASCII mode:

Command message:

STX	':'
Address	'0'
	'1'
Function	'0'
	'6'
Data address	'0'
	'1'
	'0'
	'0'
Data content	'1'
	'7'

Response message:

STX	':'
Address	'0'
	'1'
Function	'0'
	'6'
Data address	'0'
	'1'
	'0'
	'0'
Data content	'1'
	'7'

Command message:		Response message:	
	'7'		'7'
	'0'		'0'
LRC Check	'7'	LRC Check	'7'
	'1'		'1'
END	CR	END	CR
	LF		LF

RTU mode:

Command message:		Response message:	
ADR	01H	ADR	01H
CMD	08H	CMD	08H
Data	00H	Data	00H
	00H		00H
Data	17H	Data	17H
	70H		70H
CRC CHK Low	8EH	CRC CHK Low	8EH
CRC CHK High	0EH	CRC CHK High	0EH

4. CRC (Cyclical Redundancy Check) is calculated by the following steps:

Step 1: Load a 16-bit register (called CRC register) with FFFFH.

Step 2: Exclusive OR the first 8-bit byte of the command message with the low order byte of the 16-bit CRC register, storing the result in the CRC register.

Step 3: Examine the LSB of CRC register.

Step 4: If the LSB of CRC register is 0, shift the CRC register one bit to the right with MSB zero filling, then repeat step 3. If the LSB of CRC register is 1, shift the CRC register one bit to the right with MSB zero filling, Exclusive OR the CRC register with the polynomial value A001H, then repeat step 3.

Step 5: Repeat step 3 and 4 until eight shifts have been performed. When this is done, a complete 8-bit byte will have been processed.

Step 6: Repeat step 2 to 5 for the next 8-bit byte of the command message. Continue doing this until all bytes have been processed. The final content of the CRC register is the CRC value. When transmitting the CRC value in the message, the upper and lower bytes of the CRC value must be swapped, that is the lower order byte will be transmitted first.

The following is an example of CRC generation using C language. The function takes two arguments:

Unsigned char* data ← a pointer to the message buffer

Unsigned char length ← the quantity of bytes in the message buffer

The function returns the CRC value as a type of unsigned integer.

```

Unsigned int crc_chk(unsigned char* data, unsigned char length){
    int j;
    unsigned int reg_crc=0xFFFF;
    while(length--){
        reg_crc ^= *data++;
        for(j=0;j<8;j++){
            if(reg_crc & 0x01){ /* LSB(b0)=1 */
                reg_crc=(reg_crc>>1) ^ 0xA001;
            }else{
                reg_crc=reg_crc >>1;
            }
        }
    }
    return reg_crc;
}

```

5. Address list

The contents of the available addresses are shown in the following table.

Content	Address	Function		
AC motor drive Parameters	GGnnH	GG means parameter group, nn means parameter number. For example, the address of Pr.04.01 is 0401H. Refer to Chapter 4 Parameters for the function of each parameter. When reading parameters by command code 03H, only one parameter can be read at a time.		
Command Write only	2000H	bit 0–1	00B: No function 01B: Stop 10B: Run 11B: Jog + Run	
		bit 2–3	Reserved	
		bit 4–5	00B: No function 01B: FWD 10B: REV 11B: Change direction	
		bit 6–7	00B: Comm. forced first acceleration/deceleration 01B: Comm. forced second acceleration/deceleration	
		bit 8–15	Reserved	
	2001H	Frequency command		
	2002H	bit 0	1: E.F. (external fault) ON	
		bit 1	1: Reset	
		bit 2	1: B.B. ON	
		bit 3–4 bit 6–15	Reserved	
Fire mode enabled	2002H	Bit 5	00B: No function 01B: Fire mode enabled (Does not include the running commands)	
Status monitor Read only	2100H	Error code:		
		0: No error occurred		
		1: Over-current (oc)		
		2: Over-voltage (ov)		
		3: IGBT Overheat (oH1)		
		4: Reserved		
		5: Drive overload (oL)		
		6: Motor overload1 (oL1)		
		7: Over-torque (oL2)		
		8: External fault (EF)		
		9: Over-current during acceleration (ocA)		
		10: Over-current during deceleration (ocd)		
		11: Over-current during constant speed (ocn)		
		12: Reserved		
		13: Reserved		
14: PHL (Phase-Loss)				
15: Reserved				

Content	Address	Function	
		16: Auto-acceleration/deceleration failure (cFA)	
		17: Software and parameter password protection enabled (codE)	
		18: Power Board CPU WRITE failure (cF1.0)	
		19: Power Board CPU READ failure (cF2.0)	
		20: CC, OC Hardware protection failure (HPF1)	
		21: OV Hardware protection failure (HPF2)	
		22: Reserved	
		23: OC Hardware protection failure (HPF4)	
		24: U-phase error (cF3.0)	
		25: V-phase error (cF3.1)	
		26: W-phase error (cF3.2)	
		27: DC bus error (cF3.3)	
		28: IGBT Overheat error (cF3.4)	
		29: Reserved	
		30: Reserved	
		31: Reserved	
		32: Reserved	
		33: Reserved	
		34: Reserved	
		35: Reserved	
		36: Reserved	
		37: OPHL	
		Status of the AC motor drive	
	2101H	bit 0–1	00B: RUN LED is off, STOP LED is on (the AC motor drive stops).
			01B: RUN LED blinks, STOP LED is on (when the AC motor drive decelerates to stop).
			10B: RUN LED is on, STOP LED blinks (when the AC motor drive is in standby).
			11B: RUN LED is on, STOP LED is off (when the AC motor drive runs).
		bit 2	1: JOG command
		bit 3–4	00B: FWD LED is on, REV LED is off (when the AC motor drive runs forward).
			01B: FWD LED is on, REV LED blinks (when the AC motor drive runs from reverse to forward).
			10B: FWD LED blinks, REV LED is on (when the AC motor drive runs from forward to reverse).
			11B: FWD LED is off, REV LED is on (when the AC motor drive runs in reverse).
		bit 5–7	Reserved
		bit 8	1: Master frequency is controlled by the communication interface.
		bit 9	1: Master frequency is controlled by the analog signal.

Content	Address	Function	
		bit 10	1: Operation command is controlled by the communication interface.
		bit 11–15	Reserved
	2102H	Frequency command (F)	
	2103H	Output frequency (H)	
	2104H	Output current (AXX.X)	
	2105H	Reserved	
	2106H	Reserved	
	2107H	Reserved	
	2108H	DC bus Voltage (UXXX.X)	
	2109H	Output voltage (EXXX.X)	
	210AH	Displays temperature of IGBT (°C)	
	2116H	User-defined (Low word)	
	2117H	User-defined (High word)	

Note: 2116H is the number display for Pr.00.04. The high byte of 2117H is the number of decimal places for 2116H. The low byte of 2117H is the ASCII code of the alphabetic display for Pr.00.04.

6. Exception response:

The AC motor drive is expected to return a normal response after receiving command messages from the master device. The following describes the conditions when no normal response is returned to the master device.

The AC motor drive does not receive the messages due to a communication error, and the AC motor drive has no response. The master device eventually processes a time-out condition.

The AC motor drive receives the messages without a communication error, but cannot handle them. An exception response is returned to the master device and a fault message “CExx” displays on the AC motor drive keypad. The xx of “CExx” is a decimal code equal to the exception code (described below).

In the exception response, the most significant bit of the original command code is set to 1, and an exception code that explains the condition that caused the exception is returned.

The following is an example of an exception response of command code 06H and exception code 02H.

ASCII mode:

STX	‘.’
Address Low	‘0’
Address High	‘1’
Function Low	‘8’
Function High	‘6’
Exception code	‘0’
	‘2’
LRC CHK Low	‘7’
LRC CHK High	‘7’
END 1	CR
END 0	LF

RTU mode:

Address	01H
Function	86H
Exception code	02H
CRC CHK Low	C3H
CRC CHK High	A1H

Explanation of exception codes:

Exception code	Explanation
01	Illegal function code: The function code received in the command message is not available for the AC motor drive.
02	Illegal data address: The data address received in the command message is not available for the AC motor drive.
03	Illegal data value: The data value received in the command message is not available for the AC motor drive.
04	Slave device failure: The AC motor drive is unable to perform the requested action.
10	Communication time-out: If Pr.09.03 is not equal to 0.0, and Pr.09.02 = 0–2, and there is no communication on the bus during the time-out detection period (Pr.09.03), the keypad displays “cE10”.

7. Communication program for a PC:

The following is a simple example of how to write a communication program for Modbus ASCII mode on a PC in the C language.

```
#include<stdio.h>
#include<dos.h>
#include<conio.h>
#include<process.h>
#define PORT 0x03F8 /* the address of COM1 */
/* the address offset value relative to COM1 */
#define THR 0x0000
#define RDR 0x0000
#define BRDL 0x0000
#define IER 0x0001
#define BRDH 0x0001
#define LCR 0x0003
#define MCR 0x0004
#define LSR 0x0005
#define MSR 0x0006
unsigned char rdat[60];
/* read 2 data from address 2102H of AC drive with address 1 */
unsigned char tdat[60]={':','0','1','0','3','2','1','0','2','0','0','0','2','D','7','\r','\n'};
void main(){
int i;
outportb(PORT+MCR,0x08); /* interrupt enable */
outportb(PORT+IER,0x01); /* interrupt as data in */
outportb(PORT+LCR,(inportb(PORT+LCR) | 0x80));
/* the BRDL/BRDH can be access as LCR.b7==1 */
outportb(PORT+BRDL,12); /* set baudrate=9600, 12=115200/9600*/
outportb(PORT+BRDH,0x00);
outportb(PORT+LCR,0x06); /* set protocol, <7,N,2>=06H, <7,E,1>=1AH, <7,O,1>=0AH,
<8,N,2>=07H, <8,E,1>=1BH, <8,O,1>=0BH */
for(i=0;i<=16;i++){
while(!(inportb(PORT+LSR) & 0x20)); /* wait until THR empty */
outportb(PORT+THR,tdat[i]); /* send data to THR */ }
i=0;
while(!kbhit()){
if(inportb(PORT+LSR) & 0x01){ /* b0==1, read data ready */
rdat[i++]=inportb(PORT+RDR); /* read data form RDR */
} } }
```

09.06 Reserved

09.07 **Response Delay Time** Unit: 1

Settings 0–200 (1 unit = 2 ms.) Default: 1

 Sets the response delay time after the AC motor drive receives a communication command as shown in the following diagram.

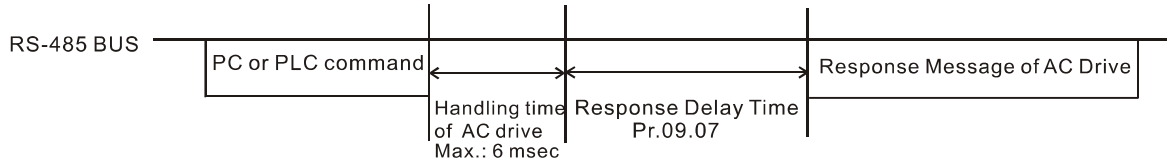



Group 10: PID Control Parameters

✎ You can set this parameter during operation.

10.00	PID Set Point Selection		Default: 0
Settings	0	Disable	
	1	Digital keypad UP/DOWN keys	
	2	Reserved	
	3	Reserved	
	4	PID set point (Pr.10.11)	

10.01	Input Terminal for PID Feedback		Default: 0
Settings	0	Positive PID feedback from external terminal AVI (0–10 V _{DC})	
	1	Negative PID feedback from external terminal AVI (0–10 V _{DC})	
	2	Positive PID feedback from external terminal ACI (4–20 mA)	
	3	Negative PID feedback from external terminal ACI (4–20 mA)	

 Note that the measured variable (feedback) controls the output frequency (Hz). Select the input terminal accordingly. Ensure that this parameter setting does not conflict with the setting for Pr.10.00 (Master Frequency).

 Negative feedback: error = set point (SP) – feedback (FB)
Positive feedback: error = feedback (FB) – set point (SP)

10.11	✎PID Set Point Value	Unit: 0.1
Settings	0.00–400.00 Hz	Default: 0.00

 Sets the set point in Hz in conjunction with Pr.10.00 setting to 4.

10.02	✎Proportional Gain (P)	Unit: 0.1
Settings	0.0–10.0	Default: 1.0

 Determines the deviation response of Proportional gain (P). Eliminates the system error; usually used to decrease the error and get faster response speed. It also reduces the steady-state error. But if you set the value too high, it may cause system oscillation and instability.

 If you set the other two gains (I and D) to zero, proportional control is the only effective parameter.

10.03	✎Integral Time (I)	Unit: 0.01
Settings	0.00–100.00 sec.	Default: 1.00
	0.00 Disable	

 Use the integral controller to eliminate the error during stable system operation. The integral control does not stop working until the error is zero. The integral is affected by the integral time.

 The smaller the integral time, the stronger the integral action. It is helpful to reduce overshoot and oscillation for a stable system. Accordingly, the speed to lower the steady-state error decreases. The integral control is often used with the other two controls for the PI controller or PID controller.

 Sets the integral time of the I controller. When the integral time is long, there is a small I controller gain, with slower response and slow external control. When the integral time is short, there is a large I controller gain, with faster response and rapid external control.



 If the integral time is too short, it may cause overshoot and system oscillation.

 Set Integral Time to 0.00 to disable Pr.10.03.



10.04	✎Differential Time (D)	Unit: 0.01
Settings	0.00–1.00 sec.	Default: 0.00

 Use the differential controller to show the system error change and to preview the change in the error. You can use the differential controller to eliminate the error in order to improve the system state. Using a suitable differential time can reduce overshoot and shorten adjustment time; however, the differential



operation increases noise interference. Note that a too large differential causes more noise interference. In addition, the differential shows the change and the output is 0 when there is no change. Note that you cannot use the differential control independently. You must use it with the other two controllers for the PD controller or PID controller.

-  Sets the D controller gain to determine the error change response. Using a suitable differential time reduces the P and I controllers overshoot to decrease the oscillation for a stable system. A differential time that is too long may cause system oscillation.
-  The differential controller acts on the change in the error and cannot reduce the interference. Do not use this function when there is significant interference.

10.05	Upper Bound for Integral Control	Unit: 1
Settings	0–100%	Default: 100

-  Defines an upper bound for the integral gain (I) and therefore limits the Master Frequency. The formula is Integral upper bound = Maximum Output Frequency (Pr.01.00) x (Pr.10.05).
-  An excessive integral value causes a slow response due to sudden load changes and may cause motor stall or machine damage.

10.06	PID Filter Time	Unit: 0.1
Settings	0.0–2.5 sec.	Default: 0.0

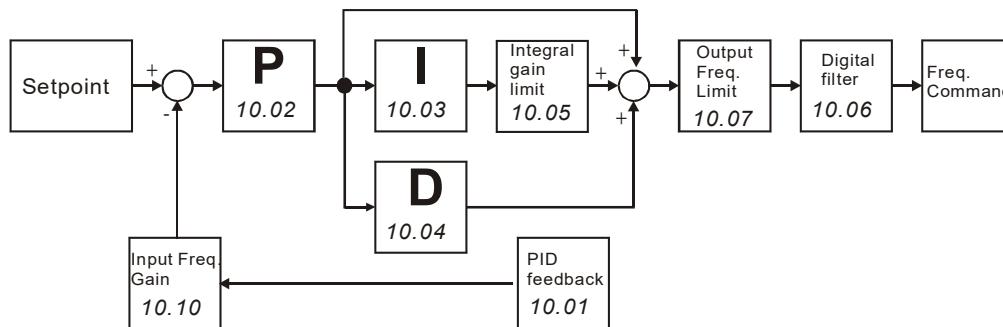

-  The output for PID filter time helps reduce the system oscillation.
-  Refer to the following closed-loop control diagram:





10.07	PID Output Frequency Limit	Unit: 1
Settings	0–110 %	Default: 100

-  Defines the percentage of the output frequency as the limit for PID control. The formula is Output Frequency Limit = Maximum Output Frequency (Pr.01.00) X Pr.10.07%. This parameter limits the Maximum Output Frequency. You can set an overall limit for the output frequency in Pr.01.07.

10.08	PID Feedback Signal Detection Time	Unit: 0.1
Settings	0.0–3600.0 sec.	Default: 60.0

-  This function is only for ACI signal.
-  Defines the time during which the PID feedback is abnormal before a warning (see Pr.10.09) is given. It can also be modified according to the system feedback signal time.
-  If you set it to 0.0, the system does not detect any abnormality signal.

10.09	Erroneous PID Feedback Signal Action	Default: 0						
Settings	<table style="width: 100%; border-collapse: collapse;"> <tr> <td style="width: 5%; text-align: center;">0</td> <td>Warn and ramp to stop</td> </tr> <tr> <td style="text-align: center;">1</td> <td>Warn and coast to stop</td> </tr> <tr> <td style="text-align: center;">2</td> <td>Warn and keep operating</td> </tr> </table>	0	Warn and ramp to stop	1	Warn and coast to stop	2	Warn and keep operating	
0	Warn and ramp to stop							
1	Warn and coast to stop							
2	Warn and keep operating							

-  This function is only for ACI signal.
-  Determines the AC motor drive action when the feedback signals (analog PID feedback) are abnormal according to Pr.10.16.

10.10	Gain Over the PID Detection Value	Unit: 0.1
	Settings 0.0–10.0	Default: 1.0

 Sets the gain adjustment over the feedback detection value. Refer to the PID closed-loop control diagram in Pr.10.06 for details.

10.12	PID Deviation Level	Unit: 0.1
	Settings 0.0–100.0%	Default: 10.0

10.13	PID Deviation Detection Time	Unit: 0.1
	Settings 0.1–300.0 sec.	Default: 5.0

 Sets the detection of the deviation between the set point and the feedback signal value.

 The base for Pr.10.12 is Pr.01.00. When the PID feedback control is enabled, and (PID set point source – feedback) is larger than Pr.10.12, and the time exceeds the Pr.10.13 setting, then the multi-function output terminal #16 (PID Feedback Error) displays as a warning and acts according to Pr.10.20 settings.

 When you set Pr.10.12 to 0, PID feedback error detection is disabled.

10.14	Sleep Detection Time	Unit: 0.1
	Settings 0.0–6550 sec.	Default: 0.0

10.15	Sleep Frequency	Unit: 0.01
	Settings 0.00–400.00 Hz	Default: 0.00

10.16	Wake-up Frequency	Unit: 0.01
	Settings 0.00–400.00 Hz	Default: 0.00

 Sleep mode setting requirements:

- PID function must be enabled.
- The wake-up frequency Pr.10.16 setting must be higher than the sleep frequency Pr.10.15, and ensure that there must be an appropriate difference between them (5 Hz or above) to prevent frequent switching between the two frequency status.
- The sleep frequency Pr.10.15 setting must be higher than the Pr.01.08 output frequency lower limit to prevent being in sleep mode.
- The sleep frequency Pr.10.15 setting must be higher than the Pr.01.05 minimum output frequency.

 Sleep/wake-up mode status description for the AC motor drive:

- When the actual output frequency $H < \text{Pr.10.15}$ and the time exceeds the Pr.10.14 setting, the AC motor drive no longer outputs and is in sleep mode after the AC motor drive decelerates to Pr.01.05 minimum output frequency following the deceleration time limit.
- When the AC motor drive is in sleep mode, the frequency command F is still calculated by PID. The state of the wake-up shows as the following diagram.
 - Before the frequency command F calculated by the PID reaches the wake-up frequency Pr.10.16, the AC motor drive is in sleep mode, and the output frequency H is 0 Hz. The duration of this period of time is affected by the PID parameters (Pr.10.02, Pr.10.03, and Pr.10.04).
 - When the frequency command F calculated by the PID reaches the wake-up frequency Pr.10.16, the AC motor drive output frequency H accelerates from Pr.01.05 minimum output frequency to Pr.10.16 wake-up frequency following the V/F curve.
 - When the actual output frequency H of the AC motor drive accelerates to Pr.10.16 wake-up frequency, control the AC motor drive output frequency H by PID.

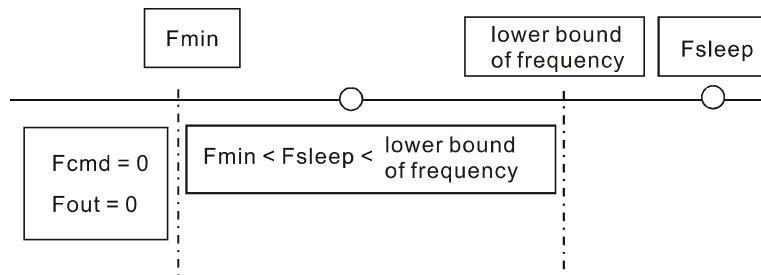
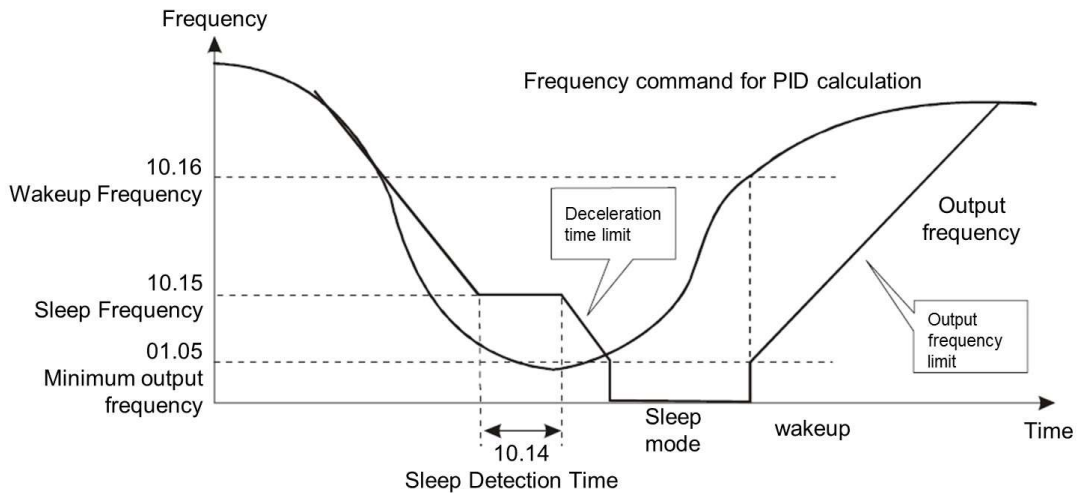

- When the PID function is enabled and the sleep mode is disabled:
 - If Pr.01.08 > Pr.01.05, the lower limit of the AC motor drive output frequency H is limited by Pr.01.08.
 - If Pr.01.08 ≤ Pr.01.05, the lower limit of the AC motor drive output frequency H is limited by Pr.01.05. When it reaches Pr.01.05, the AC motor drive stops output and is in ready status.

10.17 PID Offset Default: 0.00

Settings: 0.00–60.00 Hz

Selects the minimum output frequency in the PID control mode according to your applications.

10.18 Feedback of PID Physical Quantity Value Unit: 0.1

Settings 1.0–99.9 Default: 99.9

- When you set Pr.00.04 to 8, 00:00 displays (see the figure below).
- Use this parameter only for display. This parameter does not relate to Pr.00.13, Pr.00.14, Pr.02.18 and Pr.02.19.

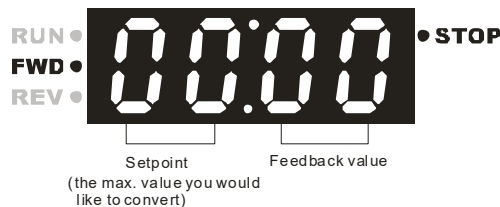

10.19 PID Calculation Mode Selection Default: 0

Settings 0 Serial mode

1 Parallel mode

Serial mode

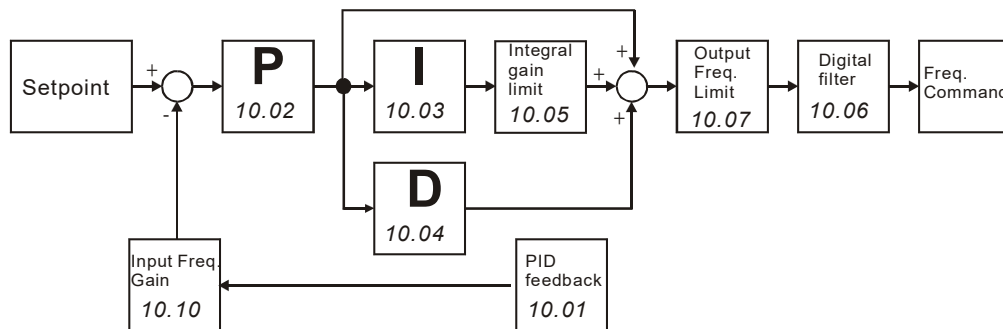

Parallel mode

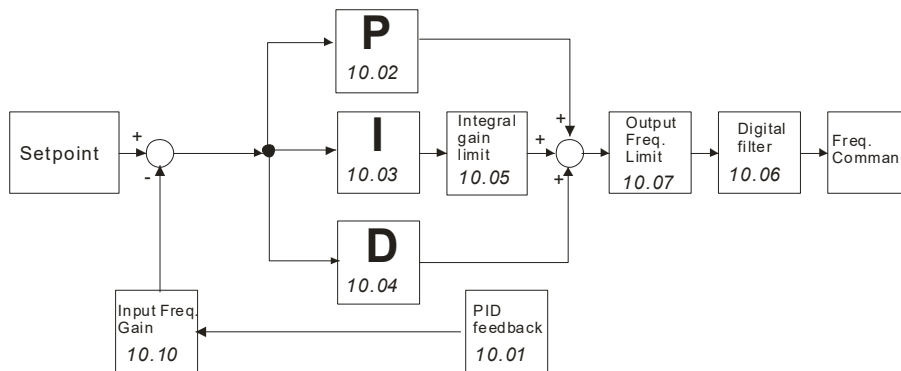

10.20 Erroneous PID Feedback Deviation Level Action Default: 0

Settings	0	Warn and keep operating
	1	Warn and coast to stop
	2	Warn and ramp to stop
	3	Ramp to stop and restart after Pr.10.21 delay time (No warning displays)
	4	Ramp to stop, and restart after Pr.10.21 delay time. The number of times of restart is limited by Pr.10.50 (Number of Times of Restart after PID Fault)

In PID control mode, the AC motor drive acts according to this parameter when erroneous PID feedback deviation level occurs (Pr.10.12 and Pr.10.13).

10.21 Restart Delay Time after Erroneous PID Deviation Level Unit: 1
 Settings 0–9999 sec. Default: 60



10.22 Set Point Deviation Level Unit: 1
 Settings 0–100% Default: 0

10.23 Detection Time of Set Point Deviation Level Unit: 1
 Settings 1–9999 sec. Default: 10

Pr.10.22 is based on the set point set by the PID control. When the deviation is less than Pr.10.22 and the time exceeds Pr.10.23 setting, the AC motor drive decelerates to stop to be in a standby status with constant pressure (this deceleration time is according to the Deceleration Time 2 in Pr.01.12). If the deviation is still in the range of the error set during deceleration to stop, the system is in standby status.



Example: Assume that the set point of a constant pressure control for a pump is 4 kg, Pr.10.22 is set to 5%, and Pr.10.23 is set to 15 seconds, then the deviation is 0.2 kg (4 kg X 5% = 0.2 kg). When the feedback value is higher than 3.8 kg and the time exceeds 15 seconds, the AC motor drive decelerates to stop (this deceleration time is according to the Deceleration Time 2 in Pr.01.12). When the feedback value is less than 3.8 kg, the AC motor drive starts to run.

10.24 Deviation Level of Liquid Leakage Unit: 1
 Settings 0–50% Default: 0

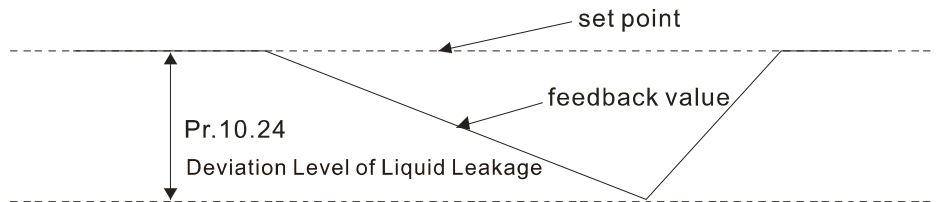

-  Pr.10.24 is based on the set point set by the PID control. When the drive does not run and is in a constant pressure status, and if the error is higher than Pr.10.24 due to liquid leakage (minor pressure loss), the AC motor drive starts to run.
-  Use this parameter to avoid the drive's frequent start-up and stop due to liquid leakage (minor pressure loss).
-  Liquid Leakage Deviation Level Detection

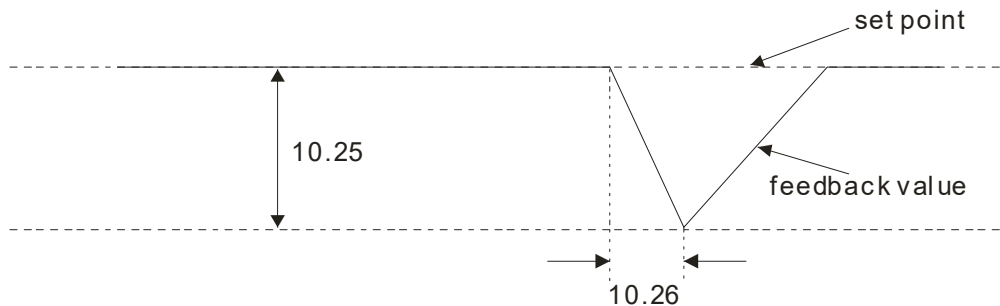

10.25	Liquid Leakage Change Detection	Unit: 1
Settings	0–100% (0: Disable)	Default: 0
10.26	Time Setting for Liquid Leakage Change	Unit: 0.1
Settings	0.1–10.0 sec. (0: Disable)	Default: 0.5

-  Pr.10.25 and Pr.10.26 define the variation of the feedback value within a time unit in the case of liquid leakage (minor pressure loss).
-  Pr.10.25 sets the variation of the feedback value based on the set point set by the PID control; Pr.10.26 is the setting value within a time unit. If the variation of the feedback value is less than the settings for Pr.10.25 and Pr.10.26, the liquid leakage occurs. When the drive does not run and is in a constant pressure status, and if the variation of the feedback value is higher than the settings for Pr.10.25 and Pr.10.26, the AC motor drive starts to run in order to keep the system stable.
-  Liquid Leakage / Usage Deviation Level Detection



-  Example:
Assume that the set point of a constant pressure control for a pump is 4 kg, Pr.10.22=5%, Pr.10.23 =15 seconds, Pr.10.24=25%, Pr.10.25=3% and Pr.10.26=0.5 second, then the deviation is 0.2 kg (4 kg X 5% = 0.2 kg). That is, when the feedback value is higher than 3.8 kg and the time exceeds 15 seconds, the AC motor drive decelerates to stop (this deceleration time is according to the Deceleration Time 2 in Pr.01.12). When the feedback value is less than 3.8 kg, the AC motor drive starts to run.
-  Case 1: Assume that when the AC motor drive does not run and is in a constant pressure status, the variation of the feedback value is less than 0.12 kg (4 kg X 3% = 0.12 kg) within 0.5 second. When the feedback value continues to decrease to make the deviation of the set point be less than 1 kg (4 kg X 25% = 1 kg), that is, when the feedback value is less than 3 kg, the AC motor drive starts to run.
-  Case 2: Assume that when the AC motor drive does not run and is in a constant pressure status, the variation of the feedback value is higher than 0.12 kg (4 kg X 3% = 0.12 kg) within 0.5 second; that is, when the feedback value is less than 3.88 kg [4 – (4 kg X 3%) = 3.88 kg] within 0.5 second, the AC motor drive starts to run.

10.27	Reserved	
10.33		
10.35	Multi-pump Control Mode	
Settings	0–2 0: Disable	Default: 0

- 1: Fixed time circulation (alternative operation)
2: Fixed quantity control (multi-pump operating at constant pressure)

 When using the multi-pump control mode, you must set Pr.10.35 for each pump to the same value.

10.36 Multi-pump ID

Settings	0–4	Default: 0
	0: Multi-pump control mode is disabled	
	1: Master	
	2–4: Slave	

 When using the multi-pump control mode, the settings of each pump for Pr.10.36 cannot be the same.

10.37 Multi-pump's Fixed Time Circulation Period

Settings	1–65535 minutes	Default: 60
----------	-----------------	-------------

 This parameter is only valid for master pump settings.

 Fixed time circulation mode (alternative operation): Assume that when pump #1's operating time is longer than the setting for Pr.10.37, pump #1 stops, and then pump #2 activates, and so on.

 Fixed quantity control (multi-pump operating at constant pressure): Assume that when the master pump's operating time is longer than the setting for Pr.10.37, the master pump and the slave pump switch alternatively.

10.38 Frequency to Start Switching Pumps

Settings	0.00 Hz– F_{MAX}	Default: 60.00
----------	--------------------	----------------

10.39 Time Detected When Pump Reaches the Starting Frequency

Settings	0.0–3600.0 sec.	Default: 1.0
----------	-----------------	--------------

10.40 Frequency to Stop Switching Pumps

Settings	0.00 Hz– F_{MAX}	Default: 48.00
----------	--------------------	----------------

10.41 Time Detected When Pump Reaches the Stopping Frequency

Settings	0.0–3600.0 sec.	Default: 1.0
----------	-----------------	--------------

 This parameter is only valid for master pump settings.

 This parameter is only valid for fixed quantity control (multi-pump operating at constant pressure) mode.

 When the master pump's operating frequency \geq Pr.10.38, and the time exceeds Pr.10.39, slave pump #1 activates. If the quantity of water is still insufficient, slave pump #2 and #3 activates under the same conditions.

 If the master pump's operating frequency \leq Pr.10.40, and the time exceeds Pr.01.41, slave pump #1 stops. If the master pump can fulfill the conditions, slave pump #2 and #3 stop in sequence, and leave the master pump in operation only.

 Whether the master pump stops depends on the stopping detection function.

10.42 Pump's Frequency at Time-out (Disconnection)

Settings	0.00 Hz– F_{MAX}	Default: 0.00
----------	--------------------	---------------

 This parameter is only valid for slave pump settings.

 For details on the conditions of communication disconnection and treatment, refer to Pr.09.02 Transmission Fault Action and Pr.09.03 Time-out Detection.

 If disconnection (time-out) occurs in the fixed quantity control (multi-pump operating at constant pressure) mode, the frequency for the slave pump is Pr.10.42. When you press the STOP key, the disconnected slave pump is in single-pump mode. (The RUN command and operating frequency is set by the parameter settings for the slave pump.)





 The master pump can re-detect the disconnection of the slave pump.

10.43 Pump's Error Treatment

Settings

Bit0–Bit2

Default: 1

-  This parameter is only valid for master pump settings.
-  Bit0: Determines whether the erroneous pump switches to an alternative pump when an error occurs in the running pump.
0: All pumps stop.
1: Switch to an alternative pump
Example:
When Bit0=0, and if an error occurs in the running pump, all pumps stop.
When Bit0=1, and if an error occurs in the running pump, switch the erroneous pump to an alternative pump.
-  Bit1: Determines the erroneous pump to be in a standby or stop status after reset.
0: Set the erroneous pump to be in a standby status after reset (the pump receives the RUN command).
1: Set the erroneous pump to be in a stop status after reset (the pump does not receive the RUN command).
Example:
When Bit1=0, and after resetting the erroneous pump, you can control its running through the controller.
When Bit1=1, and after resetting the erroneous pump, you cannot control its running through the controller until the master pump gives the STOP command.
-  Bit2: Determines whether the master pump receives the RUN command or not when an error occurs in the running pump.
0: When an error occurs in the running pump, the master pump does not receive the RUN command.
1: When an error occurs in the running pump, the master pump can choose to run with an alternative pump, instead of the erroneous pump.
Example:
When Bit2=0, the master pump does not receive the RUN command when an error occurs in drive #2.
When Bit2=1, the master pump receives the RUN command and choose to run with an alternative pump when an error occurs in drive #2.
This parameter setting is only valid for AUTO mode.

10.44 Selection of Pump's Start-up Sequence



Settings

0–1

Default: 0

0: By pump ID#

1: By running time



-  0: By pump ID#, (1→2→3→4→1)
-  1: By the shortest running time

10.45  Running Time of Multi-pump Under Alternative Operation

Settings

0.0–360.0 sec.

Default: 60.0

-  This parameter is only valid for master pump settings.
-  Sets the time for switching the master pump and the slave pump.

10.46 Reserved**10.47** Reserved**10.48** Reserved**10.49**  Specify the Setting for Pr.10.12 [PID Deviation Level]

Settings

0–1

Default: 0

0: Use the existing setting (default), and check for any error per the feedback deviation.

1: Set the low water pressure percentage (%), and check for any error per the physical quantity feedback.

-  When the pressure sensor is set to 10 kg, Pr.10.49=0 and Pr.10.12=10.0% (that is, deviation=1 kg), and if the set point=3 kg and feedback < 2 kg, then the AC motor drive follows the setting for Pr.10.20.

 When the pressure sensor is set to 10 kg, Pr.10.49=1 and Pr.10.12=10.0% (that is, the physical quantity=1 kg), and if the set point=3 kg and feedback < 1 kg, then the AC motor drive follows the setting for Pr.10.20.

10.50  Number of Times of Restart after PID Fault

Settings 0–1000 times

Default: 0

 When you set Pr.10.20 =4, this parameter sets the number of times to restart when PID error occurs.

VFD-EL-W Multi-pump SOP

STEP		
1	PID settings	The pressure feedback signal only connects to the Master, so set the PID for the master pump only. Pr.10.00 (PID Set Point Selection) Pr.10.01 (Input Terminal for PID Feedback)
2	P, I, D Gain / Time	Each AC motor drive has a PID controller, so set the following parameters for all AC motor drives. Pr.10.02 Proportional Gain (P) Pr.10.03 Integral Time (I) Pr.10.04 Differential Time (D)
3	Acceleration/ Deceleration Settings	Set the acceleration and deceleration time for each AC motor drive. Pr.01.09 (Acceleration Time 1) Pr.01.10 (Deceleration Time 1)
4	Keypad Multi-function Display	The keypad of VFD-EL-W displays the PID settings and feedback values. Set the following parameters for each AC motor drive. Pr.00.04 (Content of Multi-function Display) Setting : 5 (Display the PID analog feedback signal value in % (b) or 8 (Display the setting values for PID control and feedback signal.) Pr.00.13 (User-defined Value) Pr.00.14 (Decimal Place of User-defined Value) Pr.10.18 (Feedback of PID Physical Quantity Value)
5	Stopping Detection Function	All drives must have the stopping detection function. Set the related parameters for each AC motor drive. Pr.10.22 (Set Point Deviation Level) Pr.10.23 (Detection Time of Set Point Deviation Level) Pr.01.12 (Deceleration Time 2)
6	Liquid Leakage	All drives must have the restart function after liquid leakage. Set the related parameters for each AC motor drive. Pr.10.24 (Deviation Level of Liquid Leakage) Pr.10.25 (Liquid Leakage Change Detection) Pr.10.26 (Time Setting for Liquid Leakage Change)
7	Multi-functional Pumps	Set the Master and Slave pumps and their parameter settings according to your applications.

Optional Accessories for Multi-pumps under Alternative Operation

When you use the multi-pump operation, pay attention to the following wirings.

1. Use a RJ45 cable (8 pin, Internet cable) without an adapter. Simply connect the master/slave communication port. If there are more than two pumps, use RMKE-HUB01 to connect RJ45.



RMKE-HUB01
RS-485 One-wire to Two-wire



RJ45 Female Connector



2. Use a RJ11 (6 pin) cable with an adapter to connect the master/slave communication port.



VFD-CMD04
RS-485 RJ11
Four-port communication breakout box

Case:

For alternative operation of multi-pump (Pr.10.35=1 Fixed Time Circulation)

-  Enables four pumps to operate alternatively by time to extend their life span.
-  Keeps the water pressure at 3 kg in a water system with constant pressure.

Refer to the diagram below:

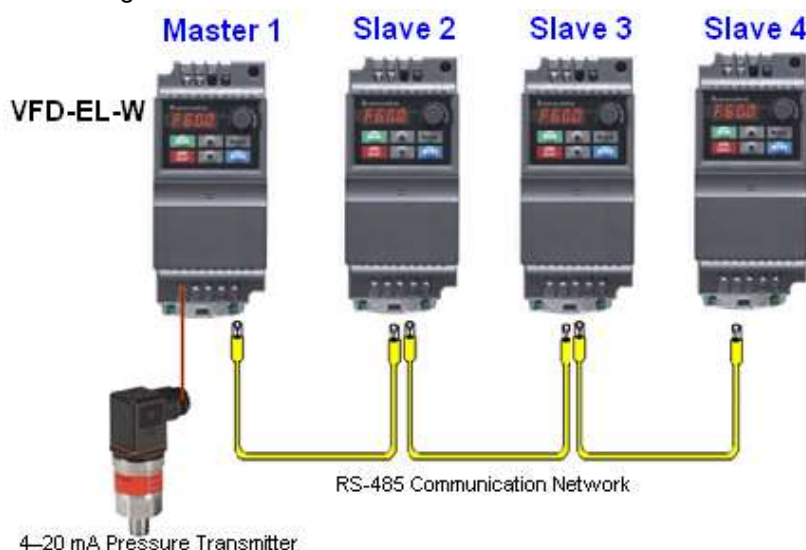

Related parameters when setting Pr.10.35=1

Parameter	Function	Settings	Default	End user's master	End user's slave	Note
↗00.03	Start-up Display Selection	0: Display the frequency command value (F) 1: Display the actual output frequency (H) 2: Display the output current in Amps supplied to the motor (A) 3: Display the content of the user-defined unit (U) 4: FWD/REV command	0	3	3	
↗00.04	Content of Multi-function Display	0: Display the content of the user-defined unit (U) 1: Display the counter value (c) 2: Display the status of multi-function input terminals (d) 3: Display the DC bus voltage (u) 4: Display the output voltage (E) 5: Display the PID analog feedback signal value in % (b) 6: Display the output power factor angle (n) 7: Display the output power (P) 8: Display the setting values for PID control and feedback signal 9: Display the AVI (I) (V) 10: Display the ACI (mA/V) (i) 11: Display the temperature of the IGBT in °C (h)	0	8	8	
00.13	User-defined Value (corresponds to max. operating frequency Pr.01.00)	0–9999	0	100	100	Sets the constant pressure control to correspond to the largest physical quantity and the decimal place. The number displayed is 10.0 currently.
00.14	Decimal Place of User-defined Value	0–3	0	1	1	

Parameter	Function	Settings	Default	End user's master	End user's slave	Note
01.00	Maximum Output Frequency (Fmax)	50.00–400.0 Hz	60.00	60.00	60.00	Follows the specifications of pumps
01.01	Motor Rated Frequency (Fbase)	0.10–400.0 Hz	60.00	60.00	60.00	
01.02	Motor Rated Voltage (Vbase)	230V series: 0.1–255.0 V 460V series: 0.1–510.0 V	220.0 440.0	220.0	220.0	

↗01.09	Accel. Time 1	0.1–600.0 / 0.01–600.00 sec.	10.0	0.5	0.5	Adjusts according to customer's applications
↗01.10	Decel. Time 1	0.1–600.0 / 0.01–600.00 sec.	10.0	5.0	5.0	
↗01.12	Decel. Time 2	0.1–600.0 / 0.01–600.00 sec.	10.0	3.0	3.0	The time the AC motor drive decelerates to stop when the pressure reaches the setting value.

Parameter	Function	Settings	Default	End user's master	End user's slave	Note
↗02.00	First Master Frequency Command Source	0: Digital keypad UP/DOWN keys or Multi-function Inputs UP/DOWN. 1: 0–10 V from AVI 2: 4–20 mA from ACI 3: RS-485 (RJ45) communication 4: Digital keypad potentiometer	0	2	2	Adjusts according to customer's applications
↗02.01	First Operation Command Source	0: Digital keypad 1: External terminals. Keypad STOP/RESET enabled. 2: External terminals. Keypad STOP/RESET disabled. 3: RS-485 communication. Keypad STOP/RESET enabled. 4: RS-485 communication. Keypad STOP/RESET disabled.	0	0	0	Adjusts according to customer's applications

Parameter	Function	Settings	Default	End user's master	End user's slave	Note
10.00	PID Set Point Selection	0: Disable 1: Digital keypad UP/DOWN keys 2: Reserved 3: Reserved 4: PID set point (Pr.10.11)	0	1	1	Adjusts according to customer's applications
10.01	Input Terminal for PID Feedback	0: Positive PID feedback from external terminal AVI (0–10 V _{DC}) 1: Negative PID feedback from external terminal AVI (0–10 V _{DC}) 2: Positive PID feedback from external terminal ACI (4–20 mA) 3: Negative PID feedback from external terminal ACI (4–20 mA)	0	3	3	
↗10.02	Proportional Gain (P)	0.0–10.0	1.0	1.2	1.2	Adjusts according to customer's applications
↗10.03	Integral Time (I)	0.00–100.00 sec. (0.00=Disable)	1.00	0.7	0.7	
↗10.04	Differential Time (D)	0.00–1.00 sec.	0.00	-	-	
10.12	PID Deviation Level	0.0–100.0%	10.0	5	5	When the pressure feedback is < 0.5 kg and time > 15 sec., follow the settings for Pr.10.20.
10.13	PID Deviation Detection Time	0.1–300.0 sec.	5.0	15	15	
10.18	Feedback of PID Physical Quantity Value	1.0–99.9	99.9	10	10	Sets the maximum feedback of PID physical quantity value to be 10 kg.
10.19	PID Calculation Mode Selection	0: Serial mode 1: Parallel mode	0	1	1	The parallel PID calculation mode applies for the constant pressure water supply control.
10.20	Erroneous PID Feedback Deviation Level Action	0: Warn and keep operating 1: Warn and coast to stop 2: Warn and ramp to stop 3: Ramp to stop and restart after Pr.10.21 delay time	0	3	3	When there is water shortage or unusual pressure feedback, the pump stops running for 1800 sec. (30 minutes) until the pressure feedback is back to normal.
10.21	Restart Delay Time after Erroneous PID Deviation Level	0–9999 sec.	60	1800	1800	

↗10.22	Set Point Deviation Level	0–100%	0	5	5	When the feedback value and the set point deviation are both 0.15 kg (3 kg X 5%=0.15 kg), that is, when feedback value is ≥ 2.85 kg and time > 10 seconds, the AC motor drive starts to decelerate to stop. This deceleration time is according to the Deceleration Time 2 in Pr.01.12.
↗10.23	Detection Time of Set Point Deviation Level	1–9999 sec.	10	10	10	When the feedback value is < 2.85 kg, the AC motor drive starts to run.
↗10.24	Deviation Level of Liquid Leakage	0–50%	0	33	33	Liquid Leakage: Assume that when the AC motor drive does not run and is in a constant pressure status, the variation of the feedback value is less than 0.12 kg (3 kg X 4% = 0.12 kg) within 2 seconds. When the feedback value continues to decrease to make the deviation of the set point be less than 0.99 kg (3 kg X 33% = 0.99 kg), that is, when the feedback value is less than 2.01 kg, the AC motor drive starts to run.
↗10.25	Liquid Leakage Change Detection	0–100% (0: Disable)	0	4	4	Liquid Usage after Liquid Leakage: Assume that when the AC motor drive does not run and is in a constant pressure status, the variation of the feedback value is higher than 0.12 kg (3 kg X 4% = 0.12 kg) within 2 seconds, the AC motor drive starts to run.
↗10.26	Time Setting for Liquid Leakage Change	0.1–10.0 sec. (0: Disable)	0.5	2	2	

10.35	Multi-pump Control Mode	0: Disable 1: Fixed time circulation (alternative operation) 2: Fixed quantity control (multi-pump operating at constant pressure)	0	1	1	
10.36	Multi-pump ID	0: Multi-pump control mode is disabled 1: Master 2–4: Slave	0	1	2	
↗10.37	Multi-pump's Fixed Time Circulation Period	1–65535 minutes	60	1	1	
↗10.42	Pump's Frequency at Time-out (Disconnection)	0.00 Hz–FMAX	0.00	60	60	
10.43	Pump's Error Treatment	Bit0: Determines whether the erroneous pump switches to an alternative pump when an error occurs in the running pump. 0: All pumps stop. 1: Switch to an alternative pump Bit1: Determines the erroneous pump to be in a standby or stop status after reset. 0: Standby after reset. 1: Stop after reset. Bit2: Determines whether the master pump receives the RUN command or not when an error occurs in the running pump. 0: Does not receives the RUN command. 1: Choose to run with an alternative pump.	1	1	1	000=0 001=1 010=2 011=3 100=4 101=5 110=6 111=7
10.44	Selection of Pump's Start-up Sequence	0: By pump ID# 1: By running time	0	1	1	Adjusts according to customer's applications
↗10.45	Running Time of Multi-pump Under Alternative Operation	0.0–360.0 sec.	60.0	60.0	60.0	Adjusts according to customer's applications

For multi-pump operating at constant pressure (Pr.10.35=2 Fixed Quantity Control)

Related parameters when setting Pr.10.35=2

Parameter	Function	Settings	Default	End user's master	End user's slave	Note
↗00.03	Start-up Display Selection	0: Display the frequency command value (F) 1: Display the actual output frequency (H) 2: Display the output current in Amps supplied to the motor (A) 3: Display the content of user-defined unit (U) 4: FWD/REV command	0	3	3	
↗00.04	Content of Multi-function Display	0: Display the content of the user-defined unit (U) 1: Display the counter value (c) 2: Display the status of multi-function input terminals (d) 3: Display the DC bus voltage (u) 4: Display the output voltage (E) 5: Display the PID analog feedback signal value in % (b) 6: Display the output power factor angle (n) 7: Display the output power (P) 8: Display the setting values for PID control and feedback signal 9: Display the AVI (I) (V) 10: Display the ACI (mA/V) (i) 11: Display the temperature of the IGBT in °C (h)	0	8	8	
00.13	User-defined Value (corresponds to max. operating frequency Pr.01.00)	0–9999	0	100	100	Sets the constant pressure control to correspond to the largest physical quantity and the decimal place. The number displayed is 10.0 currently.
00.14	Decimal Place of User-defined Value	0–3	0	1	1	

Parameter	Function	Settings	Default	End user's master	End user's slave	Note
01.00	Maximum Output Frequency (Fmax)	50.00–400.0 Hz	60.00	60.00	60.00	Follows the specifications of pumps
01.01	Motor Rated Frequency (Fbase)	0.10–400.0 Hz	60.00	60.00	60.00	
01.02	Motor Rated Voltage (Vbase)	230V series: 0.1–255.0 V 460V series: 0.1–510.0 V	220.0 440.0	220.0	220.0	
↗01.09	Accel. Time 1	0.1–600.0 / 0.01–600.00 sec.	10.0	0.5	0.5	Adjusts according to customer's applications
↗01.10	Decel. Time 1	0.1–600.0 / 0.01–600.00 sec.	10.0	5.0	5.0	
↗01.12	Decel. Time 2	0.1–600.0 / 0.01–600.00 sec.	10.0	3.0	3.0	The time the AC motor drive decelerates to stop when the pressure reaches the setting value.

Parameter	Function	Settings	Default	End user's master	End user's slave	Note
↗02.00	First Master Frequency Command Source	0: Digital keypad UP/DOWN keys or Multi-function Inputs UP/DOWN. 1: 0–10 V from AVI 2: 4–20 mA from ACI 3: RS-485 (RJ45) communication 4: Digital keypad potentiometer	0	2	2	Adjusts according to customer's applications
↗02.01	First Operation Command Source	0: Digital keypad 1: External terminals. Keypad STOP/RESET enabled. 2: External terminals. Keypad STOP/RESET disabled. 3: RS-485 communication. Keypad STOP/RESET enabled. 4: RS-485 communication. Keypad STOP/RESET disabled.	0	0	0	Adjusts according to customer's applications

Parameter	Function	Settings	Default	End user's master	End user's slave	Note
10.00	PID Set Point Selection	0: Disable 1: Digital keypad UP/DOWN keys 2: Reserved 3: Reserved	0	1	1	Adjusts according to customer's applications

Parameter	Function	Settings	Default	End user's master	End user's slave	Note
		4: PID set point (Pr.10.11)				
10.01	Input Terminal for PID Feedback	0: Positive PID feedback from external terminal AVI (0–10 V _{DC}) 1: Negative PID feedback from external terminal AVI (0–10 V _{DC}) 2: Positive PID feedback from external terminal ACI (4–20 mA) 3: Negative PID feedback from external terminal ACI (4–20 mA)	0	3	3	
↗10.02	Proportional Gain (P)	0.0–10.0	1.0	1.2	1.2	Adjusts according to customer's applications
↗10.03	Integral Time (I)	0.00–100.00 sec. (0.00=Disable)	1.00	0.7	0.7	
↗10.04	Differential Time (D)	0.00–1.00 sec.	0.00	-	-	
10.12	PID Deviation Level	0.0–100.0%	10.0	5	5	When the pressure feedback is < 0.5 kg and time > 15 sec., follow the settings for Pr.10.20.
10.13	PID Deviation Detection Time	0.1–300.0 sec.	5.0	15	15	
10.18	Feedback of PID Physical Quantity Value	1.0–99.9	99.9	10	10	Sets the maximum feedback of PID physical quantity value to be 10 kg.
10.19	PID Calculation Mode Selection	0: Serial mode 1: Parallel mode	0	1	1	The parallel PID calculation mode applies for the constant pressure water supply control.
10.20	Erroneous PID Feedback Deviation Level Action	0: Warn and keep operating 1: Warn and coast to stop 2: Warn and ramp to stop 3: Ramp to stop and restart after Pr.10.21 delay time	0	3	3	When there is water shortage or unusual pressure feedback, the pump stops running for 1800 sec. (30 minutes) until the pressure feedback is back to normal.
10.21	Restart Delay Time after Erroneous PID Deviation Level	0–9999 sec.	60	1800	1800	
↗10.22	Set Point Deviation Level	0–100%	0	5	5	When the feedback value and the set point deviation are both 0.15 kg (3 kg X 5%=0.15 kg), that is, when feedback value is ≥ 2.85 kg and time > 10 seconds, the AC motor drive starts to

Parameter	Function	Settings	Default	End user's master	End user's slave	Note
↗ 10.23	Detection Time of Set Point Deviation Level	1–9999 sec.	10	10	10	decelerate to stop. This deceleration time is according to the Deceleration Time 2 in Pr.01.12. When the feedback value is < 2.85 kg, the AC motor drive starts to run.
↗ 10.24	Deviation Level of Liquid Leakage	0–50%	0	33	33	Liquid Leakage: Assume that when the AC motor drive does not run and is in a constant pressure status, the variation of the feedback value is less than 0.12 kg (3 kg X 4% = 0.12 kg) within 2 seconds. When the feedback value continues to decrease to make the deviation of the set point be less than 0.99 kg (3 kg X 33% = 0.99 kg), that is, when the feedback value is less than 2.01 kg, the AC motor drive starts to run.
↗ 10.25	Liquid Leakage Change Detection	0–100% (0: Disable)	0	4	4	Liquid Usage after Liquid Leakage: Assume that when the AC motor drive does not run and is in a constant pressure status, the variation of the feedback value is higher than 0.12 kg (3 kg X 4% = 0.12 kg) within 2 seconds, the AC motor drive starts to run.
↗ 10.26	Time Setting for Liquid Leakage Change	0.1–10.0 sec. (0: Disable)	0.5	2	2	
10.35	Multi-pump Control Mode	0: Disable 1: Fixed time circulation (alternative operation) 2: Fixed quantity control (multi-pump operating at constant pressure)	0	2	2	
10.36	Multi-pump ID	0: Multi-pump control mode is disabled 1: Master 2–4: Slave	0	1	2	
↗ 10.37	Multi-pump's Fixed Time Circulation Period	1–65535 minutes	60	1	1	
↗ 10.42	Pump's Frequency at Time-out (Disconnection)	0.00 Hz–FMAX	0.00	60	60	

Parameter	Function	Settings	Default	End user's master	End user's slave	Note
10.43	Pump's Error Treatment	<p>Bit0: Determines whether the erroneous pump switches to an alternative pump when an error occurs in the running pump. 0: All pumps stop 1: Switch to an alternative pump</p> <p>Bit1: Determines the erroneous pump to be in a standby or stop status after reset. 0: Standby after reset. 1: Stop after reset.</p> <p>Bit2: Determines whether the master pump receives the RUN command or not when an error occurs in the running pump. 0: Does not receives the RUN command. 1: Choose to run with an alternative pump.</p>	1	1	1	000=0 001=1 010=2 011=3 100=4 101=5 110=6 111=7
10.44	Selection of Pump's Start-up Sequence	0: By pump ID# 1: By running time	0	1	1	Adjusts according to customer's applications
↗10.45	Running Time of Multi-pump Under Alternative Operation	0.0–360.0 sec.	60.0	60.0	60.0	Adjusts according to customer's applications

This page intentionally left blank.

5-1 Over-Current (oc)

5-2 Over-Voltage (ov)

5-3 Low Voltage (Lv)

5-4 Overheat (oH1)

5-5 Overload (oL)

5-6 Keypad Display is Abnormal

5-7 Phase Loss (PHL)

5-8 Motor Does Not Run

5-9 Motor Speed Cannot be Changed

5-10 Motor Stalls During Acceleration

5-11 The Motor Does Not Run as Expected

5-12 Electromagnetic / Induction Noise

5-13 Operating Environment Condition

5-14 Affecting Other Machines

5.1 Over-Current (oc)

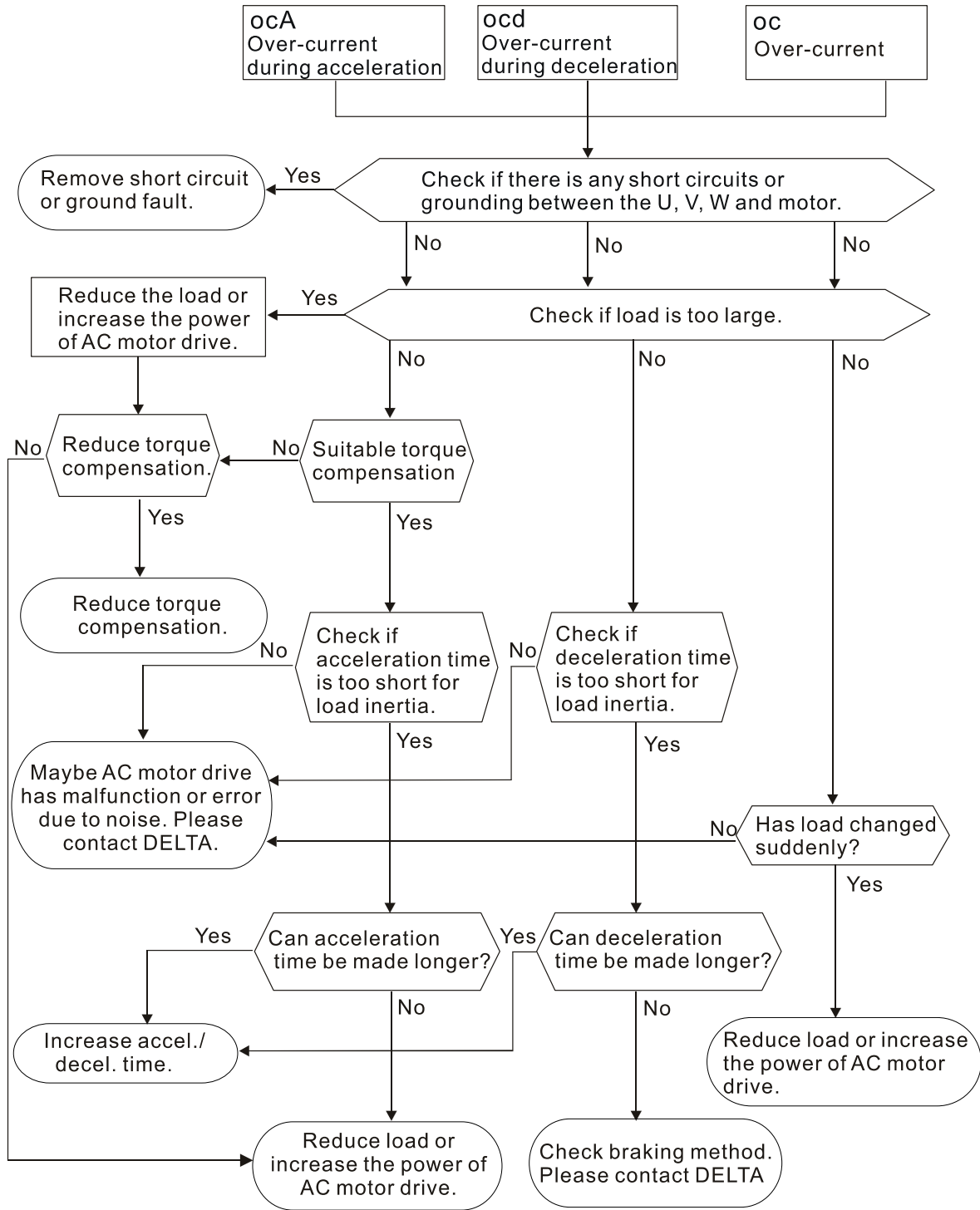

5.2 Over-Voltage (ov)

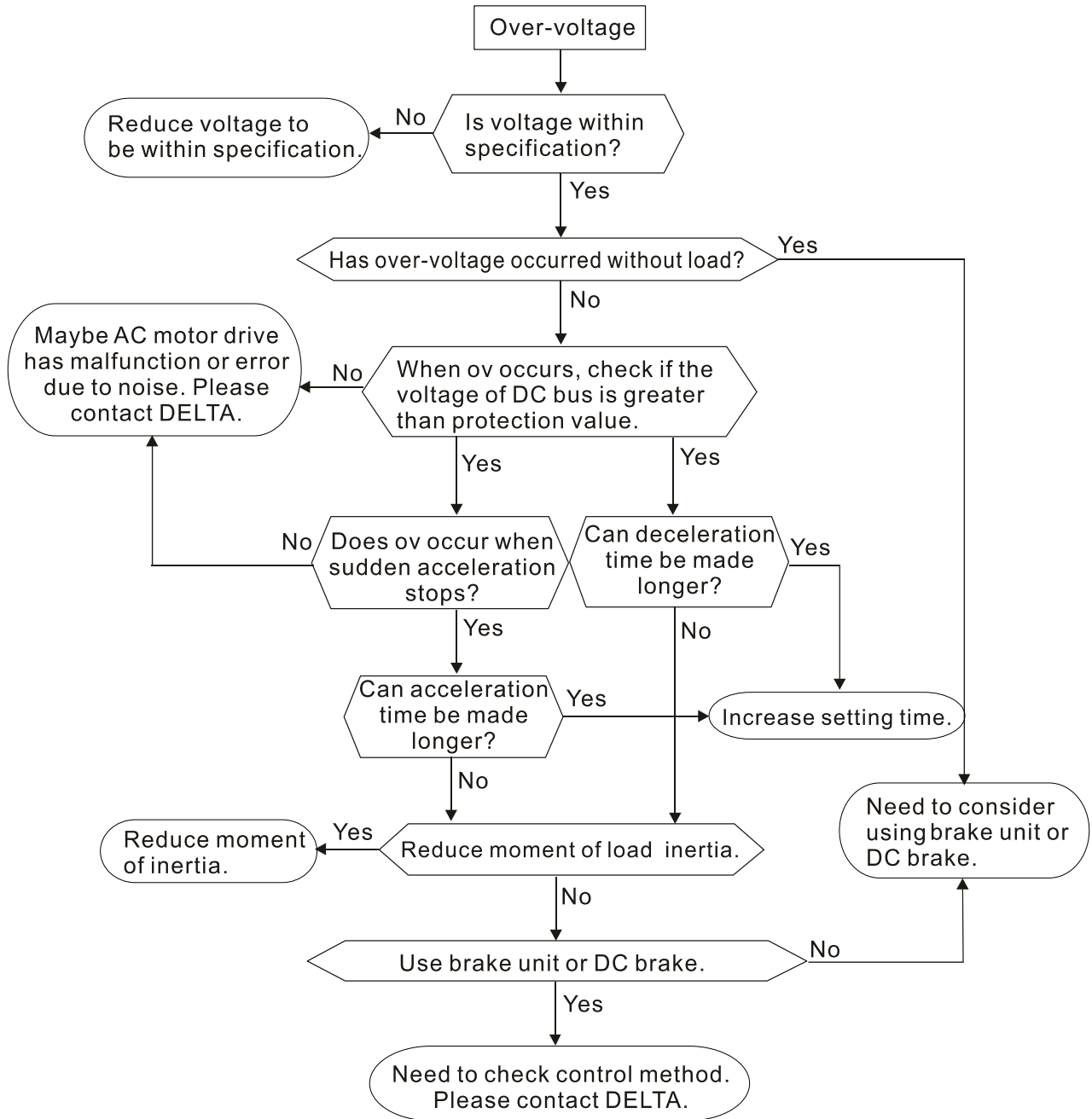

5.3 Low Voltage (Lv)

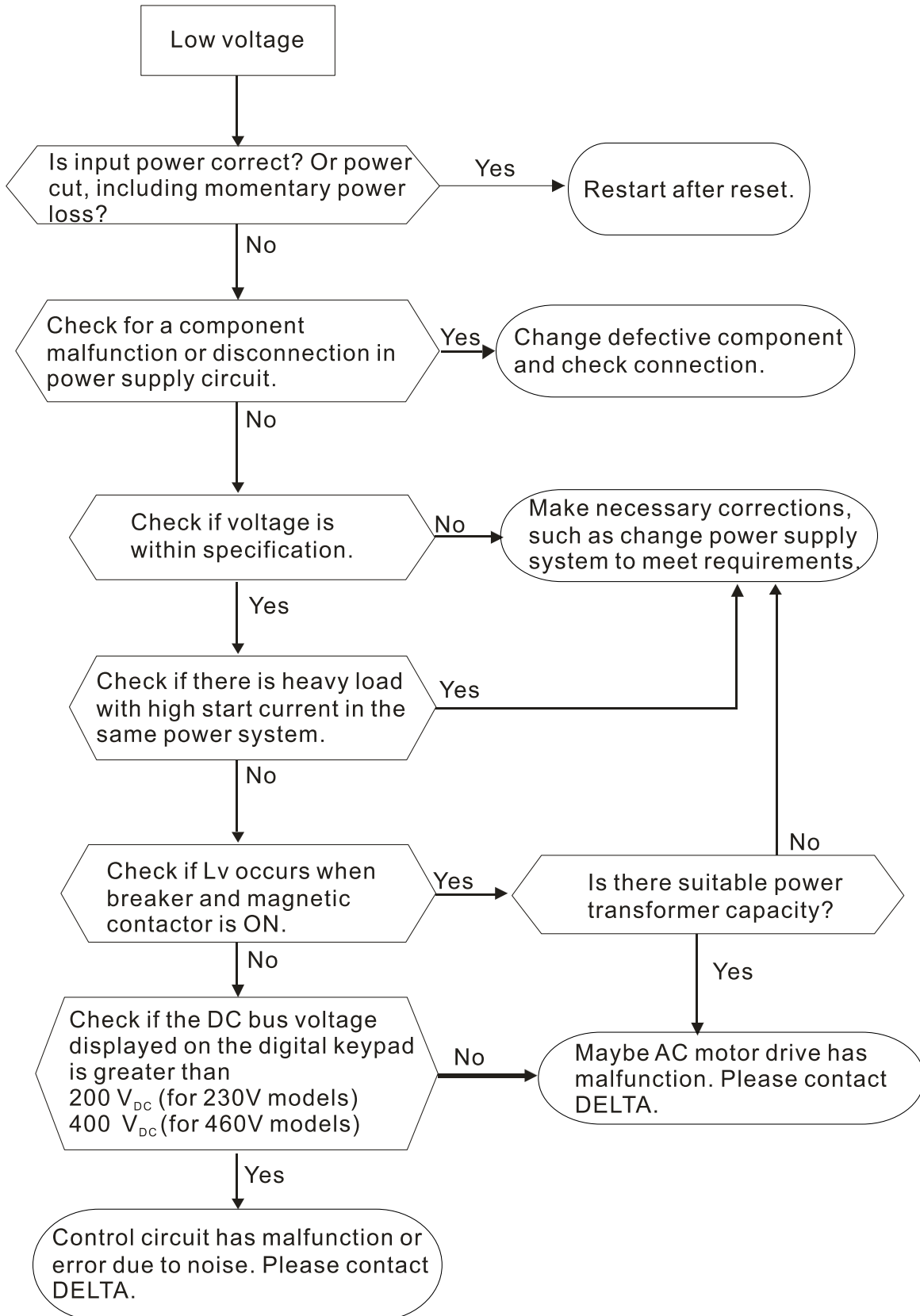

5.4 Overheat (oH1)

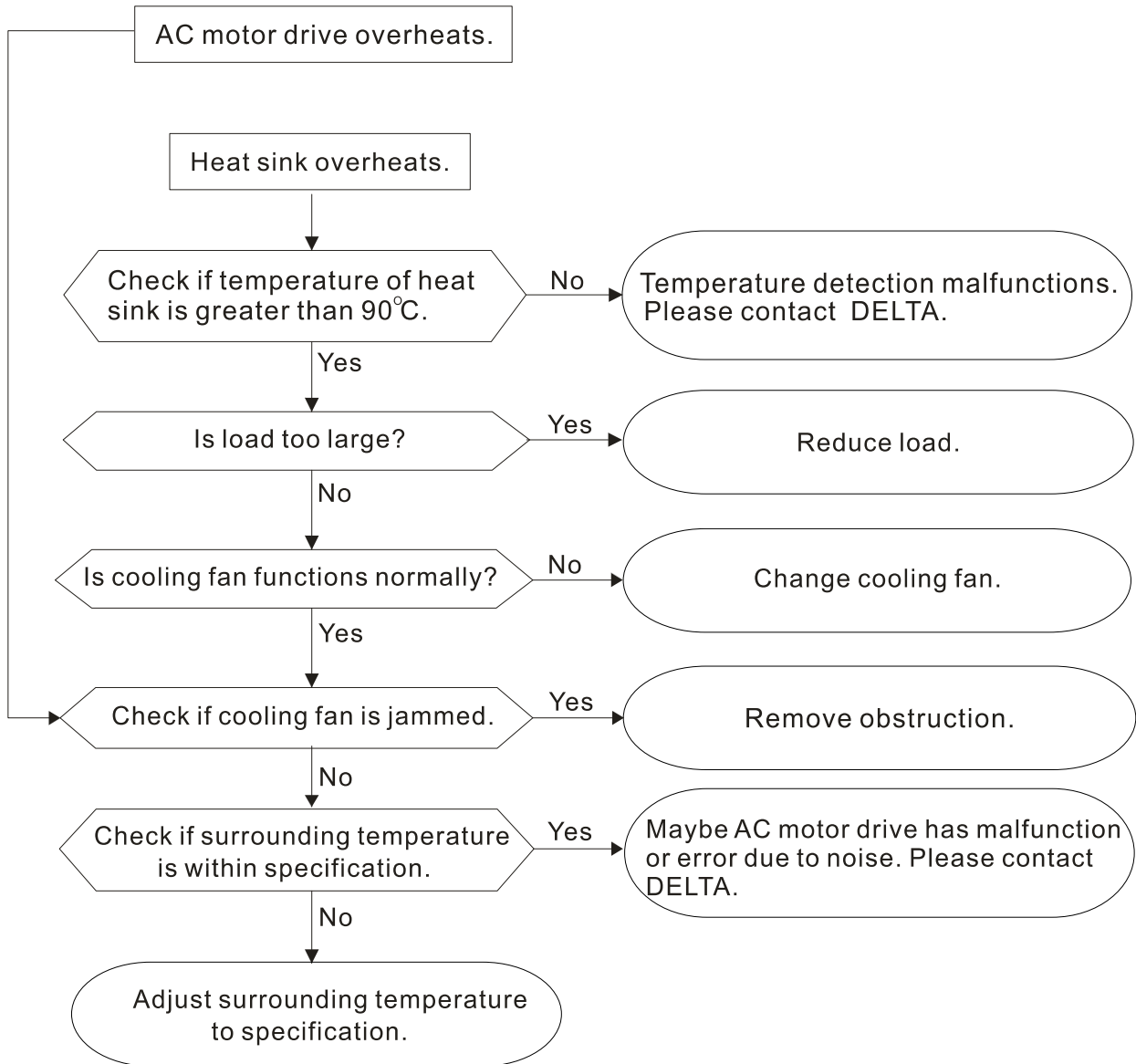

5.5 Overload (oL)

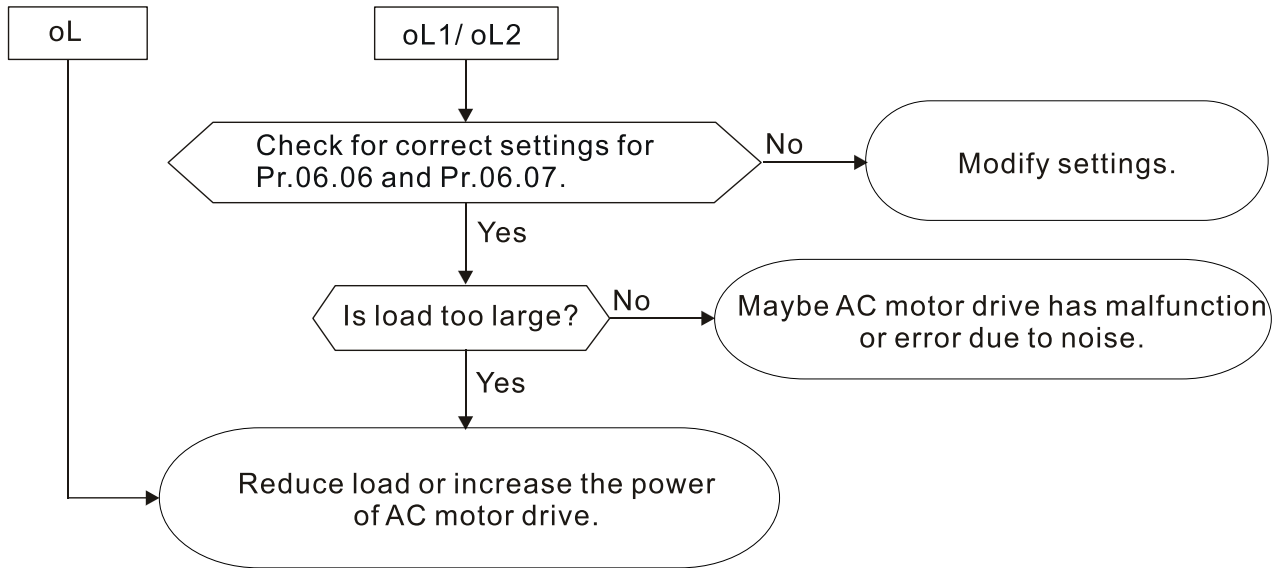

5.6 Keypad Display is Abnormal

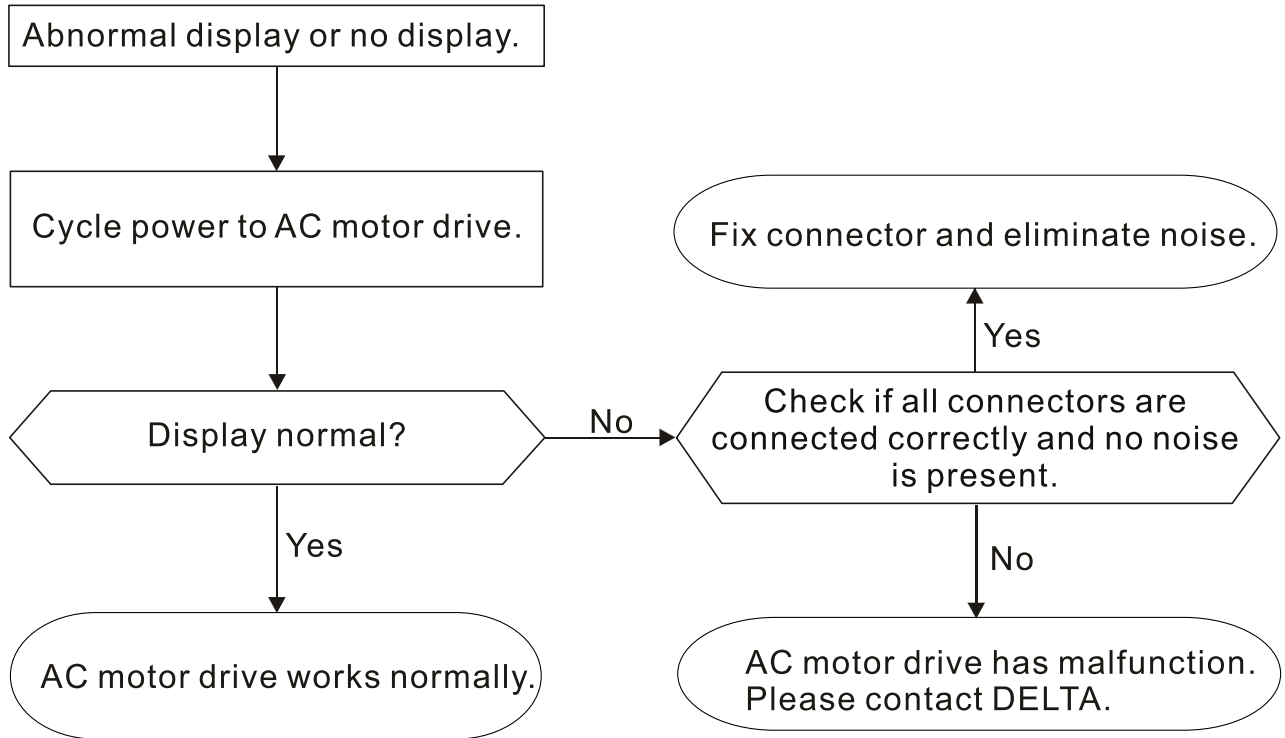

5.7 Phase Loss (PHL)

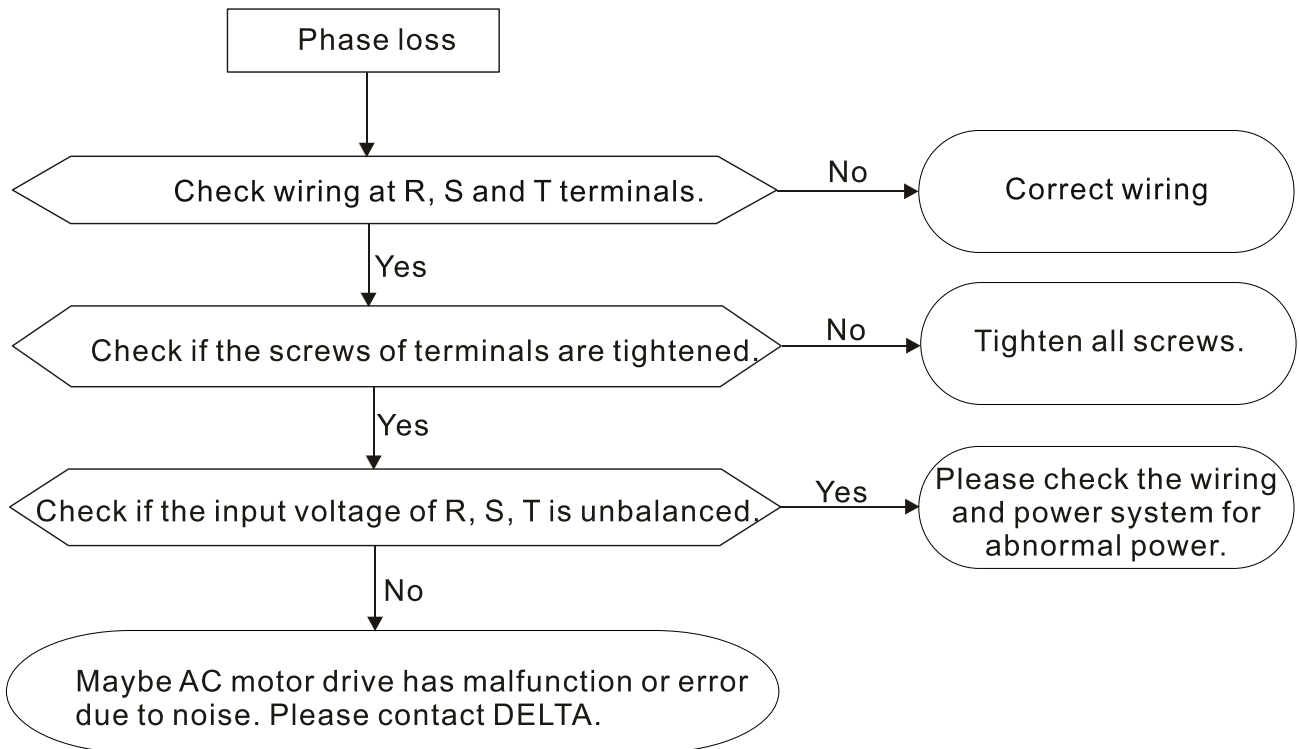

5.8 Motor Does Not Run

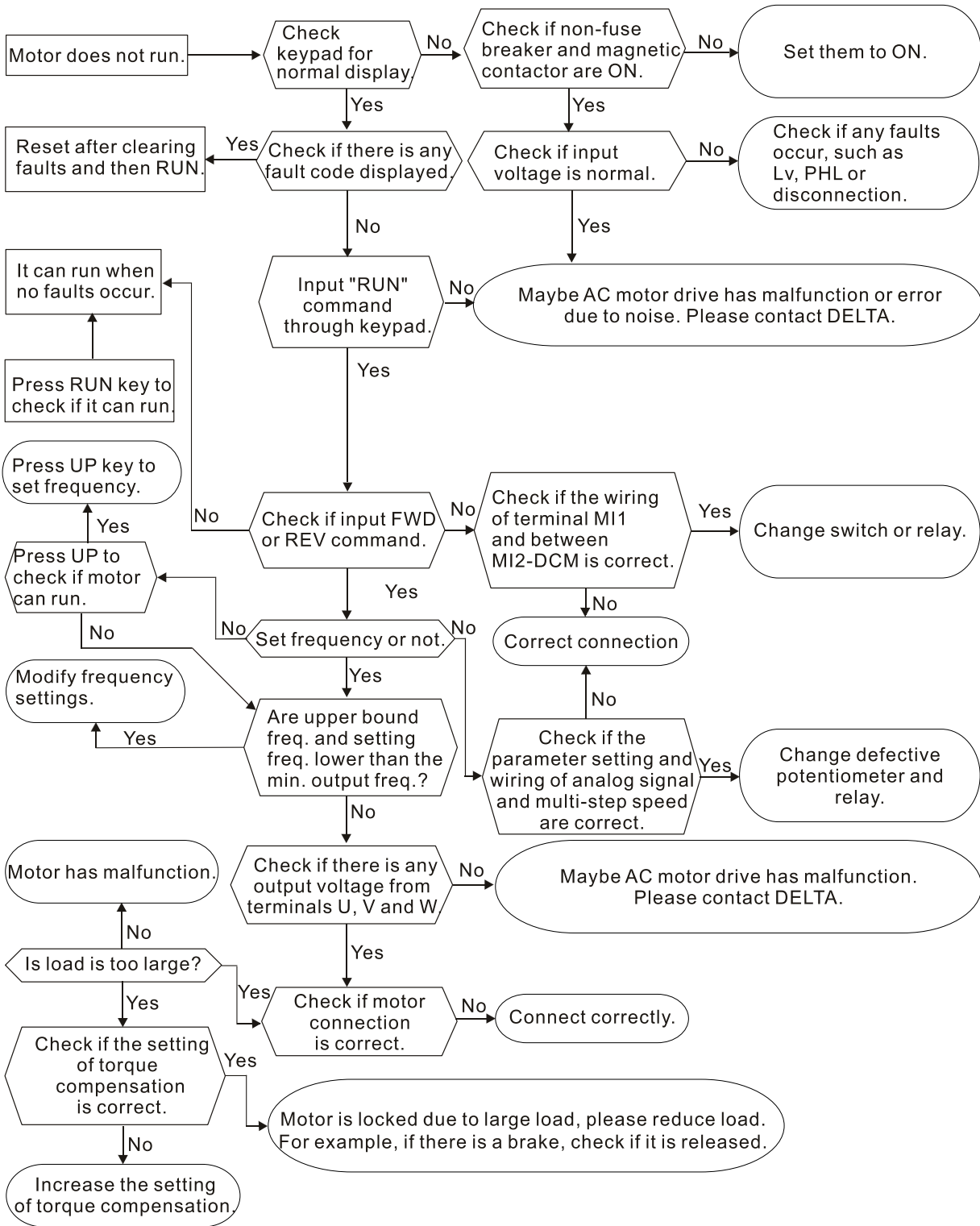

5.9 Motor Speed Cannot be Changed

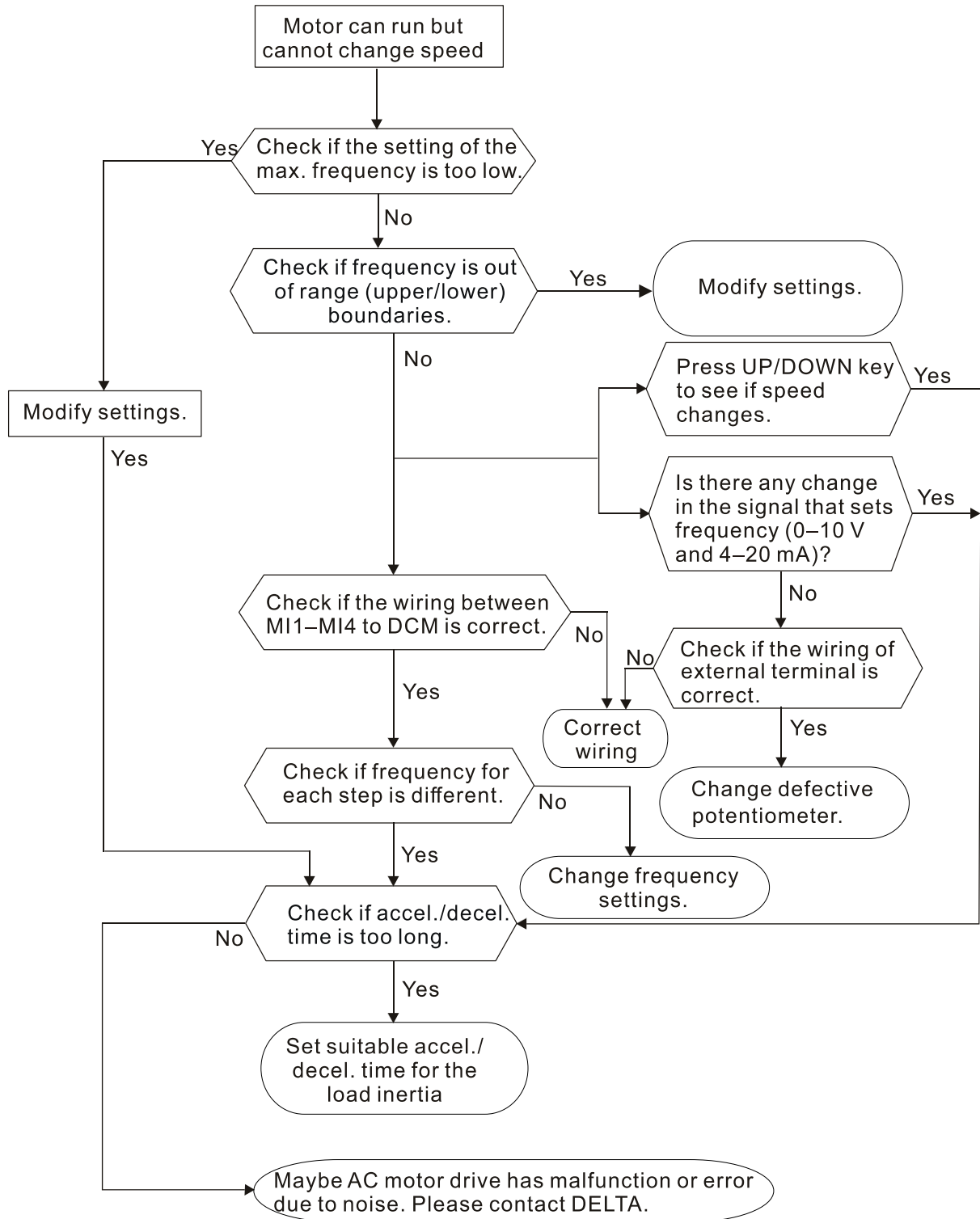

5.10 Motor Stalls During Acceleration

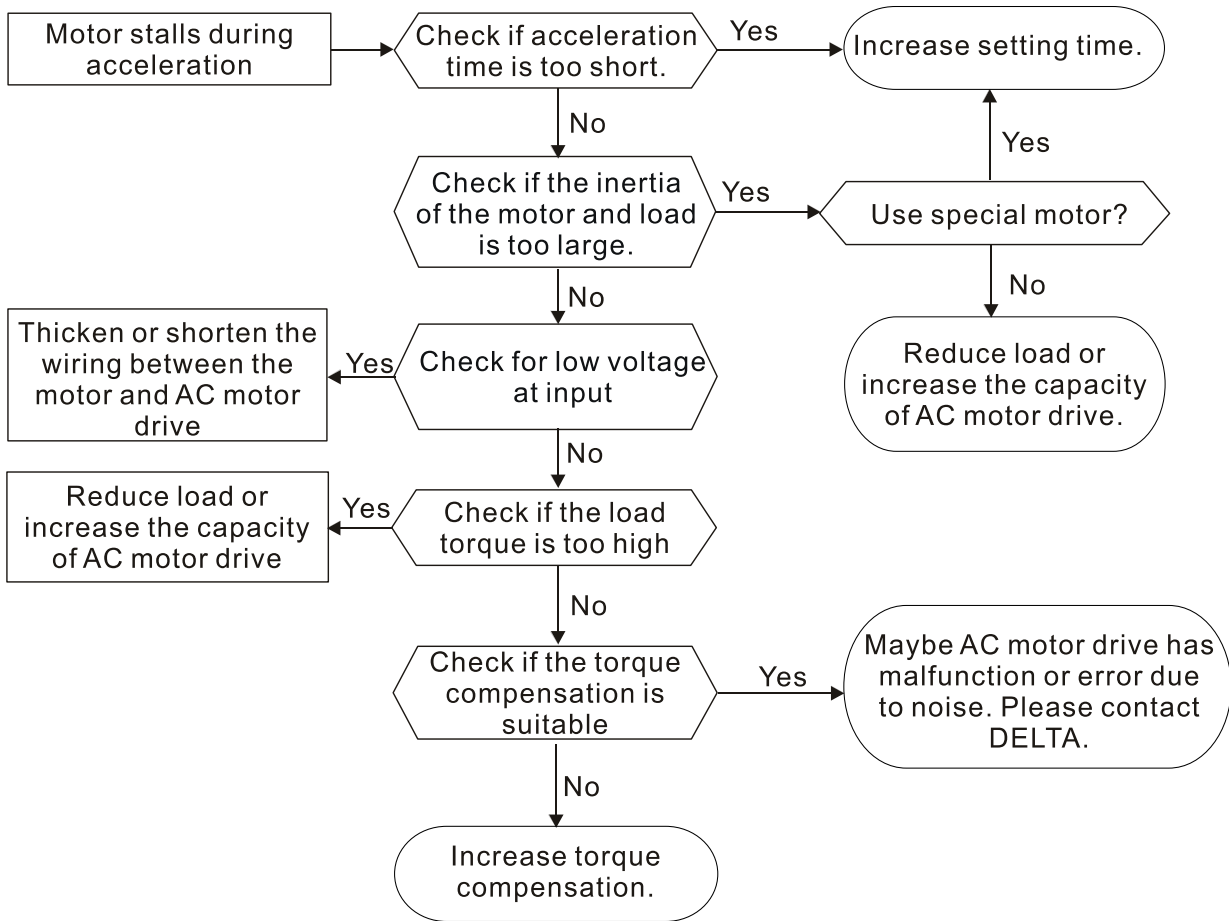

5.11 The Motor Does Not Run as Expected

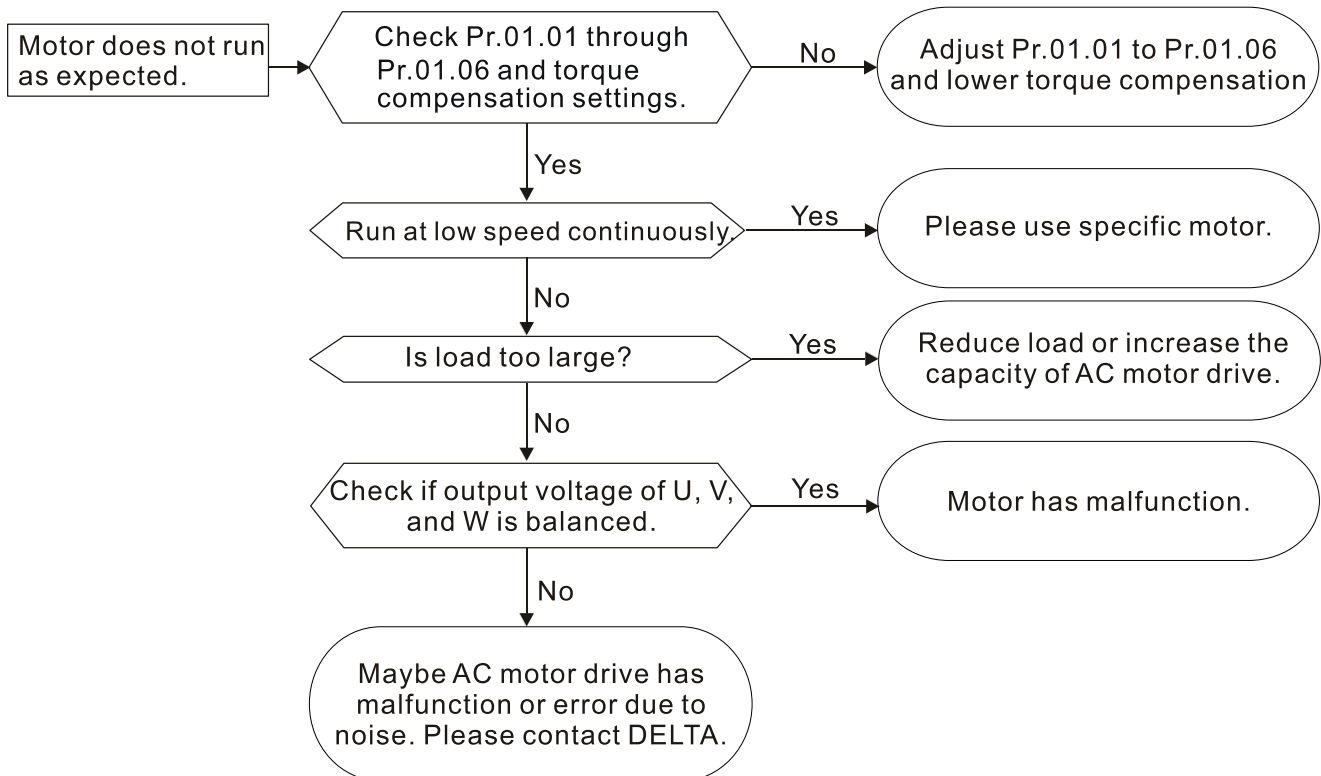

5.12 Electromagnetic/Induction Noise

Many sources of noise surround AC motor drives and affect them by radiation or conduction. This may cause the control circuits to malfunction and even damage the AC motor drive. Of course, there are solutions to increase the noise tolerance of an AC motor drive, but this has its limits. Solving the problem from the outside as follows is the best.

1. Add a surge suppressor on the relays and contacts to suppress switching surges.
2. Shorten the length of the wiring for the control circuit or serial communication and keep them separated from the power circuit wiring.
3. Comply with the wiring regulations by using shielded wires and isolation amplifiers for long wire length.
4. The grounding terminal must comply with the local regulations and be grounded independently; that is, do not use a common ground with electric welding machines and other power equipment.
5. Connect a noise filter at the mains input terminal of the AC motor drive to filter noise from the power circuit.

In short, solutions for electromagnetic noise exist of “no product” (disconnect disturbing equipment), “no spread” (limit emission from disturbing equipment) and “no receive” (enhance immunity).

5.13 Operating Environment Condition

Since the AC motor drive is an electronic device, you must deal with the operating environment conditions. Here are some remedial measures to use if necessary.

1. To prevent vibration, anti-vibration dampers are the last choice. Vibration must be within the specification. Vibration causes mechanical stress and it should not occur frequently, continuously or repeatedly to prevent damage to the AC motor drive.
2. Store the AC motor drive in a clean and dry location, free from corrosive fumes/dust to prevent corrosion and poor contacts. Poor insulation in a humid location can cause short circuits. If necessary, install the AC motor drive in a dust-proof and painted enclosure. If necessary in particular situations, use a completely sealed enclosure.
3. The ambient temperature should be within the specification. Too high or too low temperature affects the lifetime and reliability of the AC motor drive. For semiconductor components, damage occurs once any specification is out of range. It is necessary to periodically check air quality and the cooling fan and provide extra cooling if required. In addition, the microcomputer may not work in extremely low temperatures, making cabinet heating necessary.
4. Store the AC motor drive in a relative humidity range of 0% to 90% (non-condensing). Use an air conditioner and/or desiccator if necessary.

5.14 Affecting Other Machines

An AC motor drive may affect the operation of other machines due to many reasons. Some solutions are listed below:

■ High Harmonics at Power Side

You can reduce high harmonics at the power side during running.

1. Separate the power system: use a transformer for the AC motor drive.
2. Use a reactor at the power input terminal of the AC motor drive.
3. If using phase lead capacitors (never on the AC motor drive output!), use serial reactors to prevent damage to the capacitors from high harmonics.

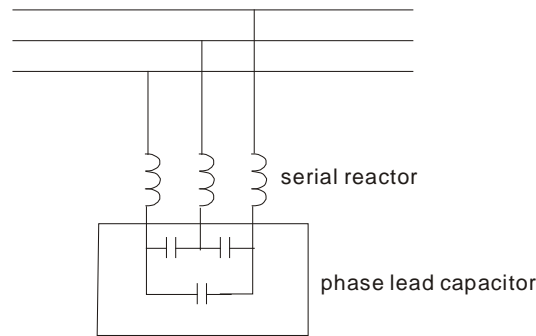

■ Motor Temperature Rises

When the motor is a standard induction motor with a fan, the cooling will be insufficient at low speed, causing the motor to overheat. In addition, high harmonics at the output increases copper and core losses. Use the following measures depending on load and operation range.

1. Use a motor with independent ventilation (forced external cooling) or increase the motor rated power.
2. Use a special inverter-duty motor.
3. Do NOT run at low speed for long periods of time.

This page intentionally left blank.

Chapter 6 Fault Code Information and Maintenance

6.1 Fault Code Information

6.2 Maintenance and Inspections

The AC motor drive has various warnings and protections against errors such as over-voltage, low voltage, or over-current. Once an error occurs, the protections activate, the AC motor drive stops output, activates the error contacts, and the motor coasts to stop. Please refer to the error display from the AC motor drive and look up the corresponding causes and solutions. The fault record is stored in the AC motor drive internal memory and can store the five most recent error messages. You can read it from the digital keypad or through the communications by accessing the parameters.

The AC motor drive includes a large number of electronic components, including ICs, resistors, capacitors, transistors, and cooling fans. These components do not last forever. Even under normal circumstances, they will eventually become error-prone if used past their lifespans. Therefore, you must perform periodic preventive maintenance to identify defective and worn out parts, and eliminate the causes of malfunctions in the AC motor drive at an early stage. At the same time, parts that have exceeded their product life should be replaced whenever possible to ensure safe operation.











Visual checks should be done regularly to monitor the AC motor drive's operation, and to make sure nothing unusual happens. Check the situations listed in the following table.

















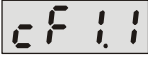







- ☑ Wait five seconds after a fault has been cleared before pressing RESET with the input terminal keypad.
- ☑ The drive must first be switched off for at least five minutes for ≤ 22 kW models until the charging indicator turns off before it is safe to open the cover to begin maintenance operations.
- ☑ Only qualified personnel can work on maintenance or replace parts. (Remove metal items such as watch, rings, and other metal items before operation, and use only insulated tools.)
- ☑ Never modify internal components or wiring.
- ☑ The performance and the surrounding environment should meet the standard specifications. There should be no abnormal noise, vibration, or odor.
- ☑ Verify if the keypad displays normally. Check if there is any abnormality such as overheating or color change. Prevent the drive from electronic shock and equipment accident.

6.1 Fault Code Information

The following messages display when the operation command source is set as digital keypad.

Fault Name	Fault Descriptions	Corrective Actions
	Over-current Abnormal increase in current.	<ol style="list-style-type: none"> 1. Check if the motor power corresponds with the AC motor drive output power. 2. Check the wiring connections to U/T1, V/T2, and W/T3 for possible short circuits. 3. Check the wiring connections between the AC motor drive and motor for possible short circuits, and for short to ground. 4. Check for loose contacts between the AC motor drive and the motor. 5. Increase the Acceleration Time. 6. Check for possible excessive loading on the motor.
	Over-voltage The DC bus voltage exceeds its maximum allowable value.	<ol style="list-style-type: none"> 1. Check if the input voltage is in the rated AC motor drive input voltage range. 2. Check for possible voltage transients. 3. DC bus over-voltage may also be caused by motor regeneration. Either increase the Deceleration Time or add an optional brake resistor (and brake unit).
	Overheating Heat sink temperature is too high.	<ol style="list-style-type: none"> 1. Ensure that the ambient temperature is in the specified temperature range. 2. Make sure that the ventilation holes are not obstructed. 3. Provide enough spacing for adequate ventilation. (see Chapter 1)
	Low voltage The AC motor drive detects that the DC bus voltage has fallen below its minimum value.	<ol style="list-style-type: none"> 1. Check whether the input voltage is in the AC motor drive rated input voltage range. 2. Check for abnormal load on the motor. 3. Check for correct input power wiring to R-S-T (for three-phase models) without phase loss.
	Overload The AC motor drive detects excessive drive output current. NOTE: The AC motor drive can withstand up to 150% of the rated current for a maximum of 60 seconds.	<ol style="list-style-type: none"> 1. Check whether the motor is overloaded. 2. Reduce the torque compensation setting (Pr.07.02). 3. Use the next higher power AC motor drive model.
	Overload 1 Internal electronic overload trip	<ol style="list-style-type: none"> 1. Check for possible motor overload. 2. Check the electronic thermal overload setting. 3. Replace the drive with a larger capacity model. 4. Reduce the current level so that the drive output current does not exceed the value in the Motor Rated Current (Pr.07.00).
	Overload 2 Motor overload.	<ol style="list-style-type: none"> 1. Reduce the motor load. 2. Adjust the over-torque detection settings to appropriate values (Pr.06.03–Pr.06.05).
	CC (current clamp)	Return the unit to the factory.
	OV hardware fault	Return the unit to the factory.
	OC hardware fault	

Fault Name	Fault Descriptions	Corrective Actions
	External Base Block 1. When the external input terminals (B.B) (MI1–MI4) are active, the AC motor drive stops output. 2. When changing the communication address 2002H bit2 = 1, the drive stops output.	The “bb” disappears once the signal source is cleared.
	Over-current during acceleration	1. Check if the screws between the drive and motor are loosen. 2. Check for possible poor insulation between the U-V-W terminals to the motor. 3. Increase the Acceleration Time. 4. Decrease the torque compensation setting (Pr.07.02). 5. Replace the drive with a larger capacity model.
	Over-current during deceleration	1. Check for possible poor insulation between the U-V-W terminals to the motor. 2. Increase the Deceleration Time. 3. Replace the drive with a larger capacity model.
	Over-current during constant speed operation	1. Check for possible poor insulation between the U-V-W terminals to the motor. 2. Check for possible motor stall. 3. Replace the drive with a larger capacity model.
	External Fault 1. When multi-function input terminals (MI1–MI4) are set to external fault, the AC motor drive stops output. 2. When changing the communication address 2002H bit0 = 1, the drive stops output.	The “EF” disappears once the signal source is cleared and reset.
	Internal EEPROM cannot be programmed.	Return the unit to the factory.
	Internal EEPROM cannot be programmed.	Return the unit to the factory.
	Internal EEPROM cannot be read.	1. Press RESET key to reset all parameters to defaults. 2. If the fault still exists, return the unit to the factory.
	Internal EEPROM cannot be read.	1. Press RESET key to reset all parameters to defaults. 2. If the fault still exists, return the unit to the factory.
	Wiring detection fault	U-phase error, return the unit to the factory.
	Wiring detection fault	V-phase error, return the unit to the factory.
	Wiring detection fault	W-phase error, return the unit to the factory.
	Wiring detection fault	DC bus wiring detection error, return the unit to the factory.
	Wiring detection fault	Temperature sensor error, return the unit to the factory.
	Auto-acceleration/deceleration failure	1. Check if the motor is suitable for operation by the AC motor drive. 2. Check if the regenerative energy is too high. 3. Check for sudden load changes.

Fault Name	Fault Descriptions	Corrective Actions
	Communication Fault	<ol style="list-style-type: none"> 1. Check the RJ45 connection between the AC motor drive for loose wires and wiring to the correct pins. 2. Check if the communication protocol is properly set. 3. Refer to Parameter Group 09 Communication Parameters in Chapter 4 for detailed information.
	PID feedback signal fault	<ol style="list-style-type: none"> 1. Check the parameter settings (Pr.10.01) and AVI/ACI wiring. 2. Check for possible fault between the system response time and the PID feedback signal detection time (Pr.10.08)
	Software protection failure	Password locked.
	Analog signal error	Check if the wiring for ACI is broken.
	Unusual PID feedback	Check if wiring for PID feedback is correct and the parameter of PID feedback is properly set.
	Phase Loss	Check if the input power is three-phase.
	Multi-motor fault protection	Check if the motor wiring is normal.

Reset

Press the “RESET” key (as shown in the figure below) to reset the external terminal after the fault is cleared, and set this terminal to be ON or send the Reset command through communication, then the trip is cleared. Make sure the RUN command or signal is OFF before executing RESET to prevent damage to the drive or personal injury due to immediate operation after reset.



Digital Keypad for EL-W

6.2 Maintenance and Inspections

Before the check-up, always turn off the AC input power for at least five minutes and remove the cover. Even if the power has been turned off, a charge may still remain in the filter capacitors with hazardous voltages before the power is OFF. Make sure the voltage is lower than 25 V_{DC} before you perform any inspections.

Ambient environment

Items to Check	Methods and Criterion	Maintenance Period		
		Daily	Half Year	One Year
Check the ambient temperature, humidity, vibration and for any dust, gas, oil or water drops.	Visual inspection and measurement with equipment with standard specifications	○		
Check for any dangerous objects in the environment.	Visual inspection	○		

Voltage

Items to Check	Methods and Criterion	Maintenance Period		
		Daily	Half Year	One Year
Check if the voltages of the main circuit and control circuit are correct.	Measure with multi-meter with standard specifications.	○		

Digital keypad display

Items to Check	Methods and Criterion	Maintenance Period		
		Daily	Half Year	One Year
Check that the display is clear for reading.	Visual inspection	○		
Check for any missing characters in the display.	Visual inspection	○		

Mechanical parts

Items to Check	Methods and Criterion	Maintenance Period		
		Daily	Half Year	One Year
Check for any abnormal sounds or vibrations.	Visual and auditory inspection		○	
Check for any loose screws.	Tighten the screws		○	
Check for deformed or damaged parts.	Visual inspection		○	
Check for any color change due to overheating.	Visual inspection		○	
Check for any dust or dirt.	Visual inspection		○	

Main circuit

Items to Check	Methods and Criterion	Maintenance Period		
		Daily	Half Year	One Year
Check for any loose or missing screws.	Tighten or replace the screws.	○		
Check for any deformed, cracked, or damaged machinery or insulation and for any color change due to overheating or ageing.	Visual inspection		○	
Check for any dust or dirt.	Visual inspection		○	

Main circuit terminals and wiring

Items to Check	Methods and Criterion	Maintenance Period		
		Daily	Half Year	One Year
Check for wiring color change or deformation due to overheating.	Visual inspection		○	
Check for wiring insulation damage or color change.	Visual inspection		○	

Main circuit terminal block

Items to Check	Methods and Criterion	Maintenance Period		
		Daily	Half Year	One Year
Check for any damage.	Visual inspection		○	

Main circuit filter capacity

Items to Check	Methods and Criterion	Maintenance Period		
		Daily	Half Year	One Year
Check for any leakage of liquid, color change, cracking or deformation.	Visual inspection	○		
Check if the safety valve is not removed or if the valve is obviously expanded.	Visual inspection	○		
Measure static capacity when required	Static capacity \geq initial value X 0.85		○	

Main circuit resistor

Items to Check	Methods and Criterion	Maintenance Period		
		Daily	Half Year	One Year
Check for any peculiar odors or insulation cracking due to overheating.	Visual inspection, smell.		○	
Check for any disconnections.	Visual inspection		○	
Check for damaged connections	Measure the resistor value with a multi-meter		○	

Main circuit transformer and reactor

Items to Check	Methods and Criterion	Maintenance Period		
		Daily	Half Year	One Year
Check for any abnormal vibrations or peculiar odors.	Visual, auditory inspection and smell.	○		

Main circuit electromagnetic contactor and relay

Items to Check	Methods and Criterion	Maintenance Period		
		Daily	Half Year	One Year
Check for any vibration sounds.	Auditory inspection.	○		
Check that the contact works correctly.	Visual inspection	○		

Main circuit printed circuit board and connector

Items to Check	Methods and Criterion	Maintenance Period		
		Daily	Half Year	One Year
Check for any loose screws and connectors.	Tighten the screws.		○	
Check for any peculiar odors or color changes.	Visual inspection and smell		○	
Check for any cracking, damage, deformation or corrosion.	Visual inspection		○	
Check for any leakage of liquid or deformation in the capacitors.	Visual inspection		○	

Cooling system cooling fan

Items to Check	Methods and Criterion	Maintenance Period		
		Daily	Half Year	One Year
Check for any abnormal sounds or vibrations.	Visual, auditory inspection and turn the fan by hand (turn off the power first) to check for smooth rotation.			○
Check for any loose screws.	Tighten the screws.			○
Check for any color change due to overheating.	Change fan.			○

Cooling system ventilation channel

Items to Check	Methods and Criterion	Maintenance Period		
		Daily	Half Year	One Year
Check for any obstruction around the heat sink, air intake or air outlet.	Visual inspection		○	

 **NOTE**

Use chemically neutral cloth to clean and use a dust cleaner to remove dust when necessary.

This page intentionally left blank.

A-1. 230V 1 ϕ Series

A-2. 460V 3 ϕ Series

A-3. General Specifications

A-4. Environment for Operation, Storage and Transportation

A-5. Operation Temperature and Derating Curve of Ambient Temperature

 **NOTE**

1. VFD-EL-W has two types of packaging: Individual Package [suffix with (-1) at the end of the model name] and 12 pcs/carton.
2. The electrical specifications are the same for either packaging.
3. The VFD-EL-W Series include the 230V and 460V models. The 230V model is one-phase; the 460V model is three-phase. Refer to following specifications for details.

A1. 230V 1 ϕ Series

Model Number VFD□□□EL21W (-1)		002	004	007	015	022
Max. Applicable Motor Output (kW)		0.2	0.4	0.75	1.5	2.2
Max. Applicable Motor Output (HP)		0.25	0.5	1.0	2.0	3.0
Output Rating	Rated Output Capacity (kVA)	0.6	1.0	1.6	2.9	4.2
	Rated Output Current (A)	1.6	2.5	4.2	7.5	11.0
	Maximum Output Voltage (V)	Three-phase Proportional to Input Voltage				
	Output Frequency (Hz)	0.1–400				
	Carrier Frequency (kHz)	2–12 (default: 8)				
Input Rating	Rated Input Current (A)	4.9	6.5	9.3	15.7	24.0
	Rated Voltage/Frequency	One-phase, 200–240 V, 50 / 60 Hz				
	Voltage Tolerance	$\pm 10\%$ (180–264 V)				
	Frequency Tolerance	$\pm 5\%$ (47–63 Hz)				
Cooling Method		Convective Cooling			Fan Cooling	
Weight (kg)		1.0	1.0	1.0	1.4	1.4

A2. 460V 3 ϕ Series

Model Number VFD□□□EL43W (-1)		004	007	015	022	040
Max. Applicable Motor Output (kW)		0.4	0.75	1.5	2.2	4.0
Max. Applicable Motor Output (HP)		0.5	1.0	2.0	3.0	5.5
Output Rating	Rated Output Capacity (kVA)	1.2	2.0	3.3	4.4	7.4
	Rated Output Current (A)	1.5	2.5	4.2	5.5	9.0
	Maximum Output Voltage (V)	Three-phase Proportional to Input Voltage				
	Output Frequency (Hz)	0.1–400				
	Carrier Frequency (kHz)	2–12 (default: 8)				
Input Rating	Rated Input Current (A)	1.8	3.2	4.3	7.1	10.0
	Rated Voltage/Frequency	Three-phase, 380–480V, 50 / 60Hz				
	Voltage Tolerance	$\pm 10\%$ (342–528 V)				
	Frequency Tolerance	$\pm 5\%$ (47–63 Hz)				
Cooling Method		Convective Cooling			Fan Cooling	
Weight (kg)		1.0	1.0	1.0	1.4	1.4

A3. General Specifications

Characteristics		Descriptions	
Control Characteristics	Control System	SPWM (Sinusoidal Pulse Width Modulation) control (V/F control, Vector Control)	
	Frequency Setting Resolution	0.01 Hz	
	Output Frequency Resolution	0.01 Hz	
	Torque Characteristics	Includes the auto-torque/auto-slip compensation; starting torque can be 150% at 5.0 Hz	
	Overload Tolerance	150% of rated current for one minute	
	Skip Frequency	Three zones, setting range 0.1–400 Hz	
	Accel/Decel Time	0.1–600 seconds (2 Independent settings for Accel./ Decel. time)	
	Stall Prevention Level	Setting 20–250% of rated current	
	DC Brake	Operation frequency 0.1–400.0 Hz, output 0–100% rated current Start time 0–60 seconds, stop time 0–60 seconds	
	V/F Pattern	Adjustable V/F pattern	
Operating Characteristics	Frequency Setting	Keypad	Setting by ▲ ▼
		External Signal	Potentiometer-5 k Ω / 0.5 W, 0–10 V _{DC} , 4–20 mA, RS-485 interface; Multi-function inputs 2 to 4 (7 steps, Jog, up/down)
	Operation Setting Signal	Keypad	Set by RUN and STOP
		External Signal	Single-wire (default setting MI1) or Two-wire/Three-wire (MI1, MI2, MI3) by setting parameters, JOG operation, RS-485 serial interface (Modbus).
	Multi-function Input Signal	Multi-step selection 0–7, Jog, accel./decel. inhibit, two accel./decel. switches, counter, external Base Block, ACI/AVI selections, drive reset, UP/DOWN key settings, NPN/PNP input selection	
	Multi-function Output Indication	AC drive operating, frequency reached, zero speed, Base Block, fault indication, overheat alarm, emergency stop and status selections for input terminals.	
Analog Output Signal	Output frequency/current		
Operation Functions	AVR, accel./decel. S-Curve, over-voltage/over-current stall prevention, five fault records, reverse inhibition, momentary power loss restart, DC brake, auto-torque/slip compensation, auto-tuning, adjustable carrier frequency, output frequency limits, parameter lock/reset, PID control, external counter, Modbus communication, abnormality reset, abnormality restart, power-saving, fan control, sleep/wake frequency, first/second frequency source selections, first/second frequency source combination, NPN/PNP selection.		
Protection Functions	Over-voltage, over-current, under-voltage, external fault, overload, ground fault, overheating, electronic thermal, IGBT short circuit, PTC		
Display Keypad	Six-key, seven-segment LED with four-digits, four status LEDs, master frequency, output frequency, output current, custom units, parameter values for setup and lock, faults, RUN, STOP, RESET, FWD/REV.		

A4. Environment for Operation, Storage and Transportation

	Built-in EMI Filter	N/A
Environmental Conditions	Enclosure Rating	IP20
	Pollution Degree	2
	Installation Location	Altitude 1,000 m or lower, keep from corrosive gasses, liquid and dust.
	Ambient Temperature	Non-condensing, non-freezing -10–50°C (40°C for side-by-side mounting, except VFD007EL21W(-1) which requires the installation of a cooling fan. Running at full load may reduce the lifespan of the drive)
	Storage/ Transportation Temperature	-20–60°C
	Ambient Humidity	Below 90% RH (non-condensing)
	Vibration	1.0 mm, peak to peak 2–13.2 Hz; 0.7–1.0 G, 13.2–55 Hz; 1.0 G, 55–512 Hz; compliance with IEC 60068-2-6
Certifications	 , RoHS, GB 12668.3	

A5. Derating Curve for Ambient Temperature and Carrier Frequency

Ambient Temperature Derating Curve

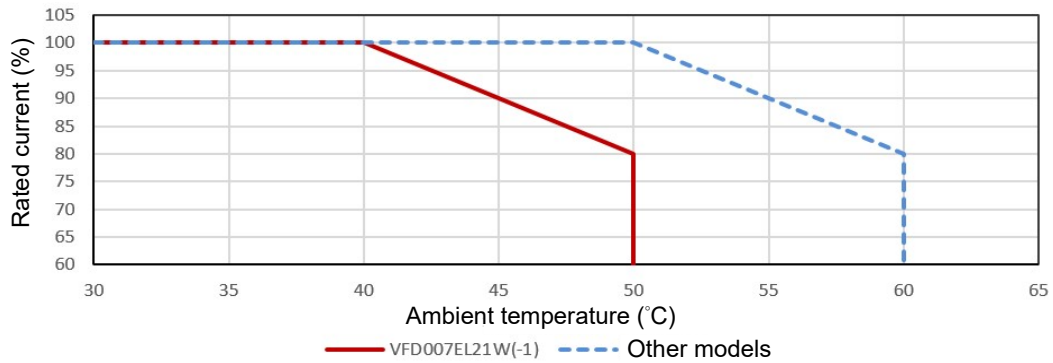

Model	Ambient Temperature Limitation
VFD007EL21W(-1)	If the AC motor drive operates at the rated current, the ambient temperature needs to be between -10–40°C. If the temperature is above 40°C, decrease 2% of the rated current for every 1°C increase in temperature. The maximum allowable temperature is 50°C.
Other models	If the AC motor drive operates at the rated current, the ambient temperature needs to be between -10–50°C. If the temperature is above 50°C, decrease 2% of the rated current for every 1°C increase in temperature. The maximum allowable temperature is 60°C.

Other models: VFD002EL21W(-1), VFD004EL21W(-1), VFD015EL21W(-1), VFD022EL21W(-1), VFD004EL43W(-1), VFD007EL43W(-1), VFD015EL43W(-1), VFD022EL43W(-1), VFD040EL43W(-1)

Carrier Frequency Derating Curve

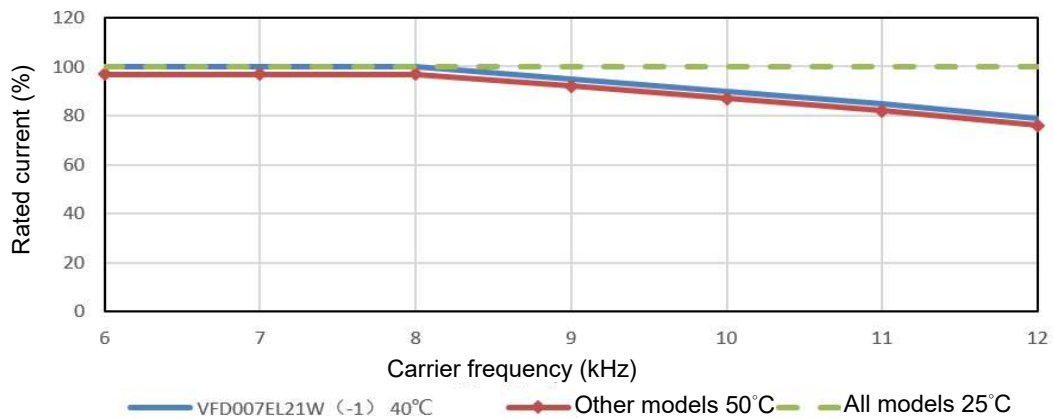

Model	Carrier Frequency Limitation
VFD007EL21W(-1)	If the AC motor drive is installed at an ambient temperature of 40°C, and operates at the rated current, the carrier frequency needs to be within 8 kHz. If the carrier frequency is higher than 8 kHz, decrease 5% of the rated current for every 1 kHz increase in the carrier frequency. The maximum allowable carrier frequency is 12 kHz.
Other models	If the AC motor drive is installed at an ambient temperature of 50°C, and operates at the rated current, the carrier frequency needs to be within 8 kHz. If the carrier frequency is higher than 8 kHz, decrease 5% of the rated current for every 1 kHz increase in the carrier frequency. The maximum allowable carrier frequency is 12 kHz.

This page intentionally left blank.

B.1 Non-fuse Circuit Breaker Chart

B.2 Reactor

B.2.1 AC Reactor

B.2.2 Zero Phase Reactor

B.3 Digital Keypad

B.3.1 PU06

B.3.2 PU08 and PU08V

B.4 Optional Cooling Fan

B.1 Non-fuse Circuit Breaker Chart

For one-phase/three-phase drives, the current rating of the breaker must be between 2–4 times the rated input current.

One-phase		Three-phase	
Model	Recommended non-fuse breaker (A)	Model	Recommended non-fuse breaker (A)
VFD002EL21W	10	VFD004EL43W	5
VFD004EL21W	15	VFD007EL43W	5
VFD007EL21W	20	VFD015EL43W	10
VFD015EL21W	30	VFD022EL43W	15
VFD022EL21W	50	VFD040EL43W	20

Fuse Specification Chart

Fuse specifications lower than the table below are allowed.

Model	I (A) Input	I (A) Output	Line Fuse	
			I (A)	Bussmann P/N
VFD002EL21W	4.9	1.6	10	JJN-10
VFD004EL21W	6.5	2.5	15	JJN-15
VFD004EL43W	1,8	1,5	5	JJS-6
VFD007EL21W	9.3	4.2	20	JJN-20
VFD007EL43W	3.2	2.5	5	JJS-6
VFD015EL21W	15.7	7.5	30	JJN-30
VFD015EL43W	4.3	4.2	10	JJS-10
VFD022EL21W	24.0	11.0	50	JJN-50
VFD022EL43W	7.1	5.5	15	JJS-15
VFD040EL43W	10.0	9.0	20	JJS-20

B.2 Reactor

B.2.1 AC Reactor

AC Input Reactor Recommended Value

230V, 50/60Hz, One-Phase

kW	HP	Fundamental Amps	Max. continuous Amps	Inductance (mH)	
				3–5% Impedance	
0.2	0.25	4	6	6.5	
0.4	0.5	5	7.5	3	
0.75	1	8	12	1.5	
1.5	2	12	18	1.25	
2.2	3	18	27	0.8	

460V, 50/60Hz, Three-Phase

kW	HP	Fundamental Amps	Max. continuous Amps	Inductance (mH)	
				3% Impedance	5% Impedance
0.4	0.5	2	3	20	32
0.75	1	4	6	9	12
1.5	2	4	6	6.5	9
2.2	3	8	12	5	7.5
4.0	5.5	8	12	3	5

AC Output Reactor Recommended Value

230V, 50/60Hz, Three-Phase

kW	HP	Fundamental Amps	Max. continuous Amps	Inductance (mH)	
				3% Impedance	5% Impedance
0.2	0.25	4	6	9	12
0.4	0.5	4	6	6.5	9
0.75	1	8	12	3	5
1.5	2	8	12	1.5	3
2.2	3	12	18	1.25	2.5

460V, 50/60Hz, Three-Phase

kW	HP	Fundamental Amps	Max. continuous Amps	Inductance (mH)	
				3% Impedance	5% Impedance
0.4	0.5	2	3	20	32
0.75	1	4	6	9	12
1.5	2	4	6	6.5	9
2.2	3	8	12	5	7.5
4.0	5.5	12	18	3	5

Applications

Connected in input circuit

Application 1

When more than one AC motor drives are connected to the same mains power and are running, and one of them is ON during operation.

Issues: When applying power to one of the AC motor drives, the charge current of the capacitors may cause voltage dip. The AC motor drive may be damaged when over-current occurs during operation.

Correct wiring:

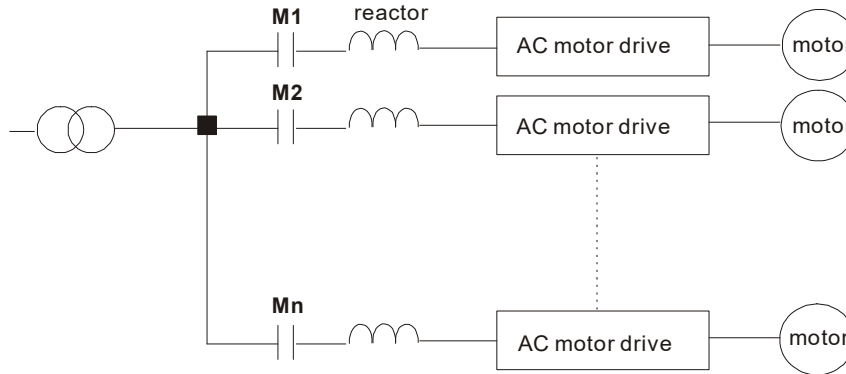

Application 2

A silicon rectifier and AC motor drive are connected to the same power.

Issues: Switching spikes are generated when the silicon rectifier switches ON/OFF. These spikes may damage the mains circuit.

Correct wiring:

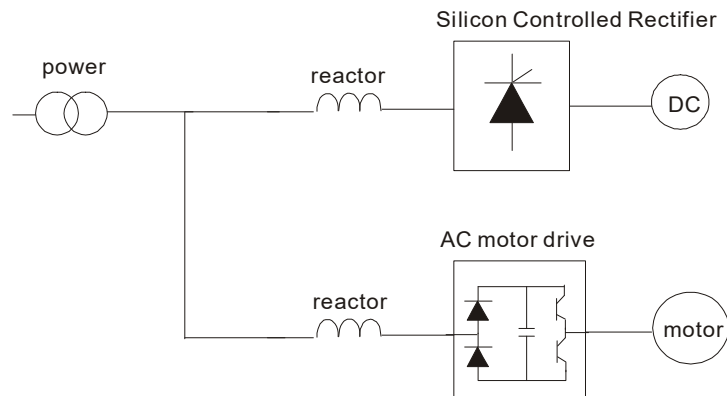

Application 3

The power supply capacity is 10 or above times the AC motor drive capacity.

Issues: When the mains power capacity is too large, line impedance is small and the charge current is too high. This may damage the AC motor drive due to the higher rectifier temperature.

Correct wiring:



B.2.2 Zero Phase Reactor RF220X00A

UNIT: mm [inch]

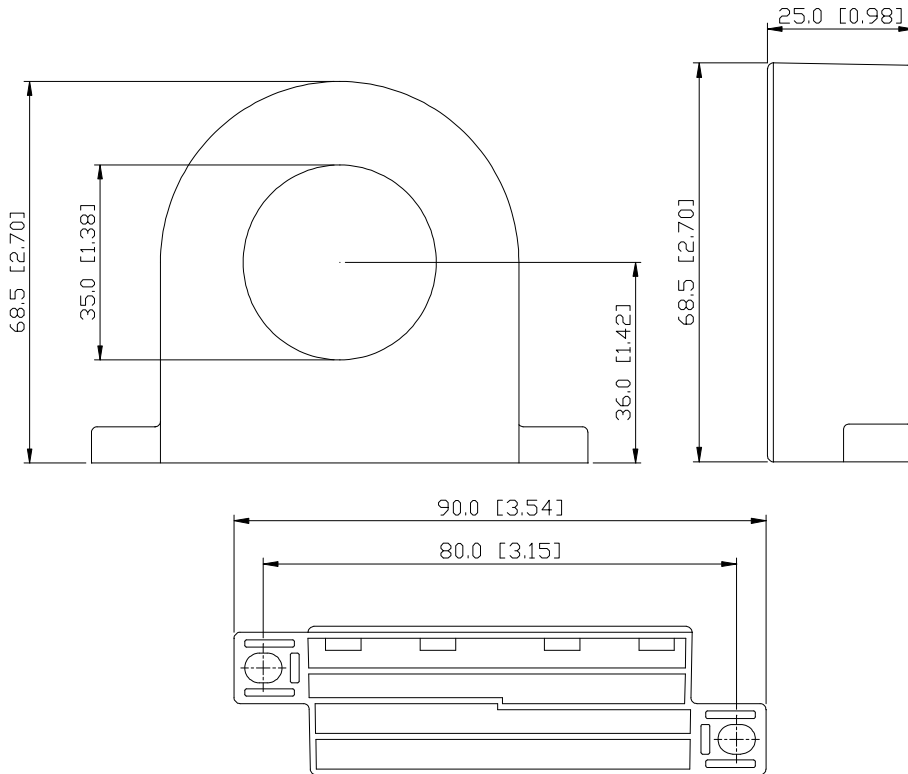

Cable type (Note)	Recommended Wire Size			Qty.	Wiring Method
	AWG	mm ²	Nominal (mm ²)		
Single-core	≤ 10	≤ 5.3	≤ 5.5	1	Diagram A
	≤ 2	≤ 33.6	≤ 38	4	Diagram B
Three-core	≤ 12	≤ 3.3	≤ 3.5	1	Diagram A
	≤ 1	≤ 42.4	≤ 50	4	Diagram B

Diagram A

Please wind each wire four times around the core. The reactor must be put as close to the inverter output as possible.

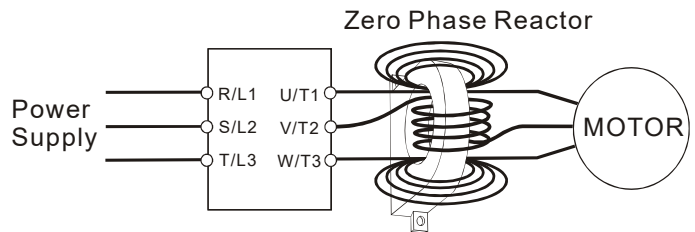

NOTE

600V Insulated Unshielded Cable

1. The table above gives approximate wire size for zero phase reactors, but the selection is ultimately governed by the type and diameter of the cable; that is, the cable must fit through the center hole of zero phase reactors.
2. When wiring, do not pass the grounding cable through the zero phase reactor; only pass the motor wire or power cable through the zero phase reactor.
3. With longer motor cables the zero-phase reactor can effectively reduce interference at the motor output.

Diagram B

Please put all wires through four cores in series without winding.

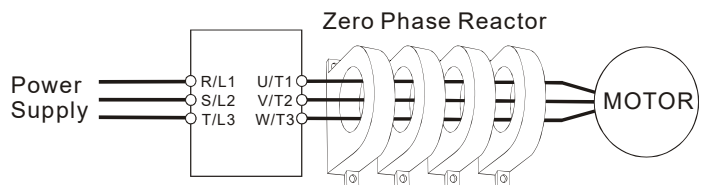

B.3 Digital Keypad

B.3.1 VFD-PU06

B.3.1.1 Digital Keypad VFD-PU06 Description

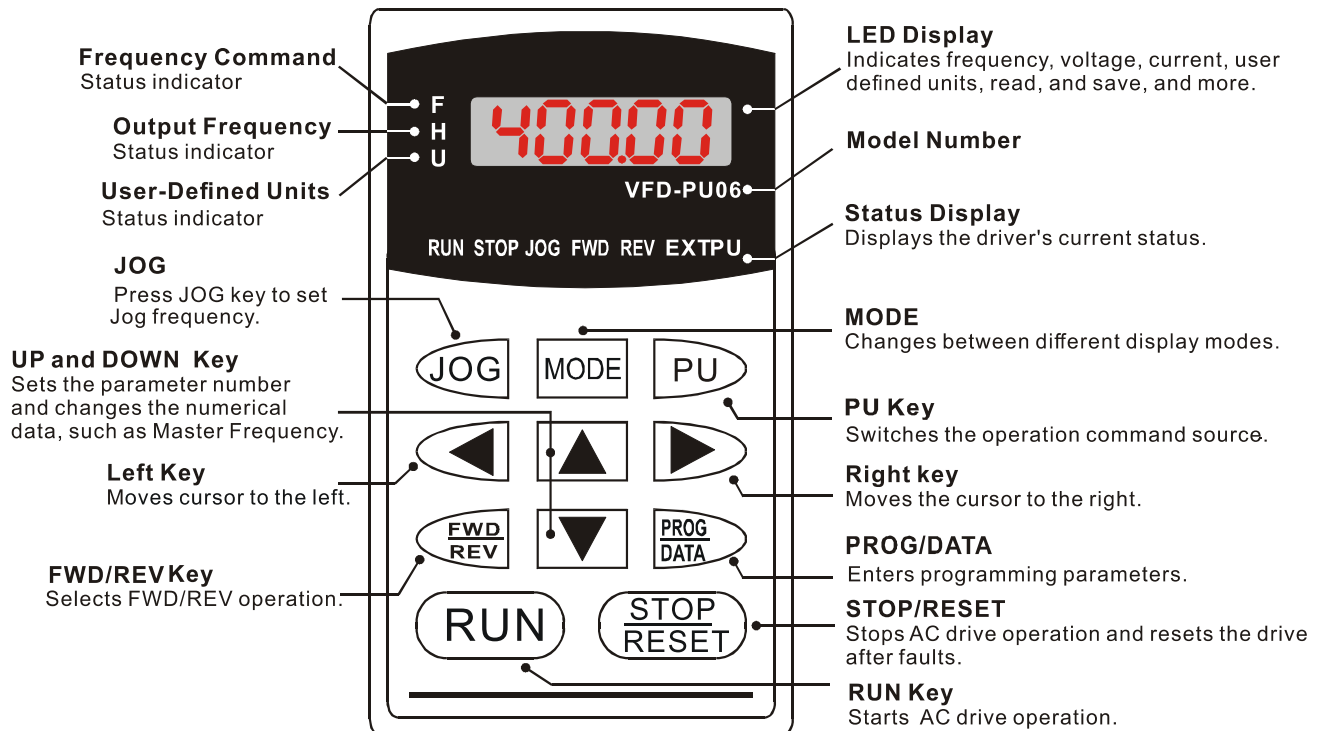

B.3.1.2 Display Message Explanation

Display Message	Descriptions
	The current frequency of the drive.
	The actual operation frequency that the drive outputs to the motor.
	The user-defined unit (u)
	The loading current of the drive.
	Read parameters. Press PROG/DATA for 2–3 sec. until it is flashing. Then, you can read four parameters from the AC motor drive to the digital keypad PU06 (read D0–read D3). Press UP or DOWN key to change to SAVE function.
	Write parameters. Press PROG/DATA for 2–3 sec. until it is flashing. Then, you can write the parameters from the digital keypad PU06 to the AC motor drive. Press UP or DOWN key to change to READ function.
	The specified parameter setting.
	The actual value stored in the specified parameter.
	External Fault

Display Message	Descriptions
	<p>“End” displays for approximately one second if the entered input data has been accepted. After a parameter value has been set, the new value is automatically stored in memory.</p>
	<p>“Err” displays if the input is invalid or the input exceeds the setting range.</p>
	<p>Communication Error. Refer to Parameter Group 09 in Chapter 04 for details.</p>

B.3.1.3 Operation Flow Chart

VFD-PU06 Operation Flow Chart

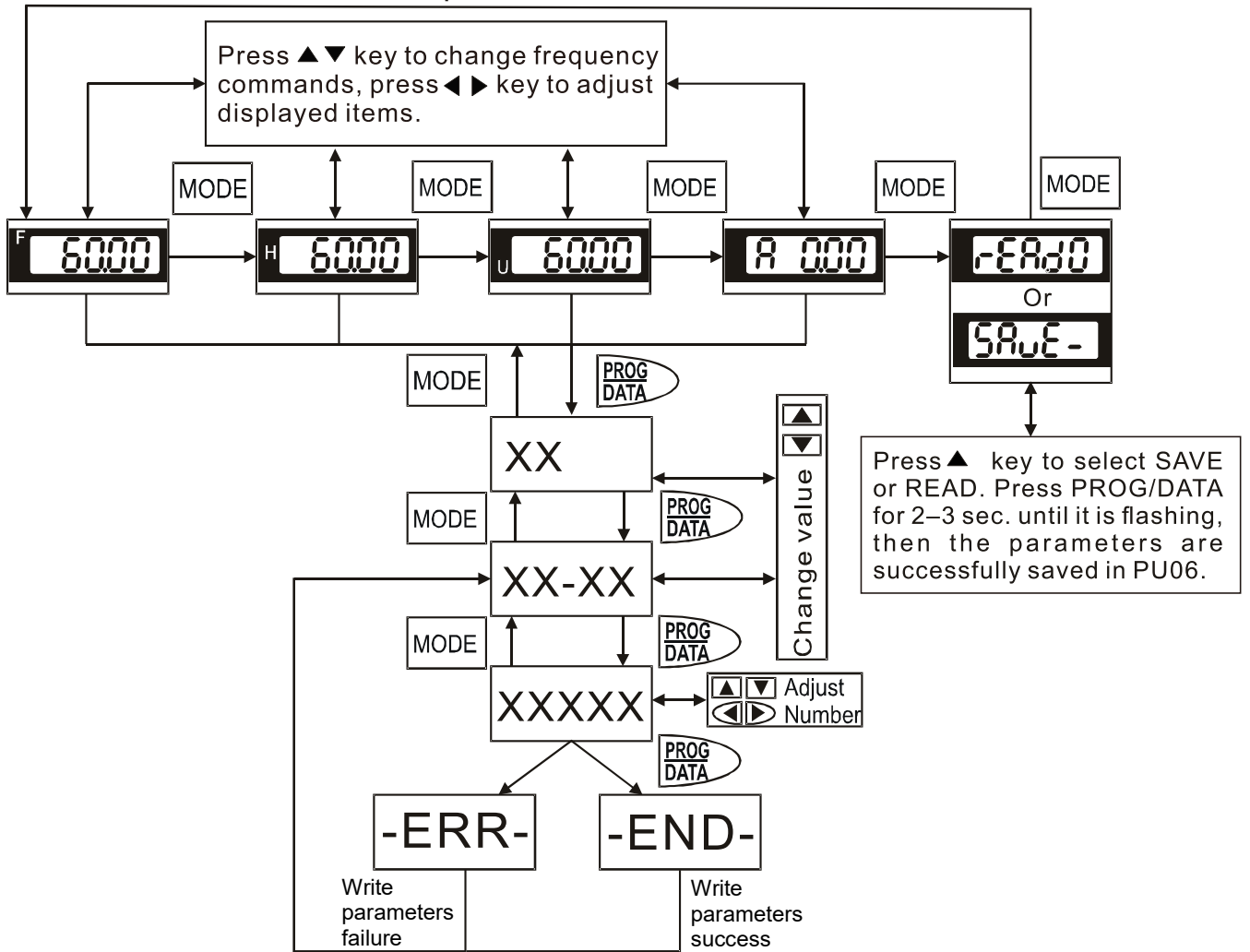

B.3.2 VFD-PU08 and VFD-PU08V

<p>VFD-PU08</p>		<table border="1"> <thead> <tr> <th>Item</th> <th>Specification</th> </tr> </thead> <tbody> <tr> <td>Compatible Drive</td> <td>VFD-EL-W, ME300</td> </tr> <tr> <td>Communication Protocol</td> <td>RS485</td> </tr> <tr> <td>Size (mm)</td> <td>PU08: W: 68.0, D: 35.6, H: 46.8. PU08V: W: 36.5, D: 31.0, H: 70.0.</td> </tr> <tr> <td>Installation method</td> <td>PU08: By snap-fit or by fastening screws. PU08V: By fastening screws.</td> </tr> <tr> <td>Protection Marking</td> <td>Front panel: IP20; Rear Panel: IP00</td> </tr> <tr> <td>Network Interface</td> <td>RJ45 (RJ: Registered Jack)</td> </tr> <tr> <td>Maximum cable length</td> <td>5 meters</td> </tr> <tr> <td>Main Function</td> <td>-RS-485 communication -Read/Write parameters, -Display status, -Send commands. -Display startup menu</td> </tr> </tbody> </table>	Item	Specification	Compatible Drive	VFD-EL-W, ME300	Communication Protocol	RS485	Size (mm)	PU08: W: 68.0, D: 35.6, H: 46.8. PU08V: W: 36.5, D: 31.0, H: 70.0.	Installation method	PU08: By snap-fit or by fastening screws. PU08V: By fastening screws.	Protection Marking	Front panel: IP20; Rear Panel: IP00	Network Interface	RJ45 (RJ: Registered Jack)	Maximum cable length	5 meters	Main Function	-RS-485 communication -Read/Write parameters, -Display status, -Send commands. -Display startup menu
Item	Specification																			
Compatible Drive	VFD-EL-W, ME300																			
Communication Protocol	RS485																			
Size (mm)	PU08: W: 68.0, D: 35.6, H: 46.8. PU08V: W: 36.5, D: 31.0, H: 70.0.																			
Installation method	PU08: By snap-fit or by fastening screws. PU08V: By fastening screws.																			
Protection Marking	Front panel: IP20; Rear Panel: IP00																			
Network Interface	RJ45 (RJ: Registered Jack)																			
Maximum cable length	5 meters																			
Main Function	-RS-485 communication -Read/Write parameters, -Display status, -Send commands. -Display startup menu																			
<p>VFD-PU08V</p>																				

 **NOTE**

The VFD-PU08 and VFD-PU08V don't not include the extension cord. Please choose the suitable extension cords as needed. (Refer to the table below)

Communication cable

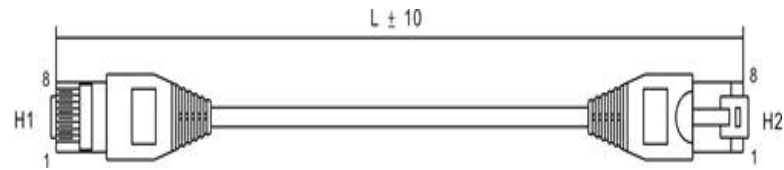

No.	Model Name	L	
		mm	inch
1	UC-CMC003-01A	300	11.8
2	UC-CMC005-01A	500	19.6
3	UC-CMC010-01A	1000	39.0
4	UC-CMC015-01A	1500	59.0
5	UC-CMC020-01A	2000	78.7
6	UC-CMC030-01A	3000	118.1
7	UC-CMC050-01A	5000	196.8

B.4 Optional Fan Kit

After you install the cooling fan to the VFD007EL21W(-1), you can increase the ambient temperature of the operating environment up to 50°C without derating. If you choose not to install the cooling fan, the ambient temperature of the operating environment is only up to 40°C without derating. The power supply of the cooling fan is 24V_{DC}. Internal power is applied from terminal +24V/DCM. Once you install this cooling fan on the motor drive, do not connect any other external accessory to avoid overload on terminal +24V which will damage the motor drive. Use only terminals MI after your install the cooling fan.

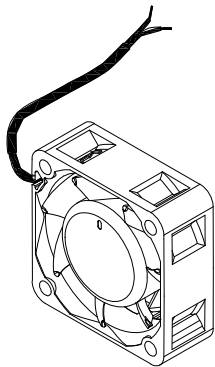
Cooling Fan Model	Applicable Motor Drive	Product Appearance
MKEL-AFKM1	VFD007EL21W(-1)	

Note: the power cable of the cooling fan is about 150mm.

Cooling Fan Installation

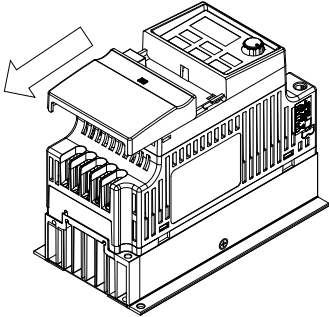
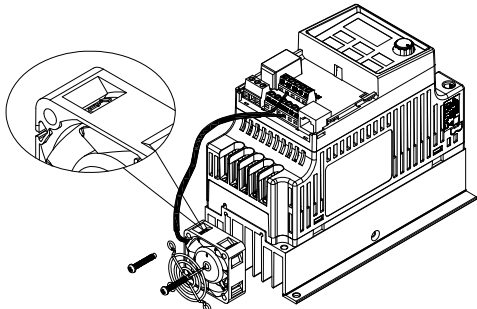
<p>1. Follow the direction of the arrow to remove the top cover.</p>	
<p>2. As shown in the image on the right, the direction pointed by the arrow on top of the cooling fan should face the heat sink. Fix the cooling fan and its grill by fastening screws on the heat sink. Positive pole of the cooling fan: Connect the red cable to terminal +24V. Negative pole of the cooling fan: Connect the black cable to terminal DCM.</p>	

3.
Replace the top cover to complete the
cooling fan installation

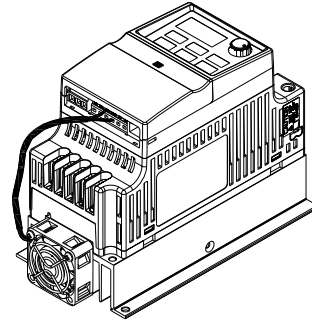

Appendix C How to Select the Right AC Motor Drive

C.1 Capacity Formulas

C.2 General Precautions

C.3 How to Choose a Suitable Motor

The choice of the right AC motor drive for the application is very important and has a big influence on the drive's lifetime. If the capacity of the AC motor drive is too large, it cannot provide complete protection to the motor and motor might be damaged. If the capacity of the AC motor drive is too small, it cannot provide the required performance and the AC motor drive might be damaged due to overloading.

Simply selecting the AC motor drive with the same capacity as the motor cannot completely meet the application requirements. Therefore, a designer should consider all the conditions, including load types, load speeds, load characteristics, operation methods, rated output, rated speed, power and the change in load capacity. The following table lists the factors you need to consider, depending on your requirements.

Item		Related Specification			
		Speed and torque characteristics	Time ratings	Overload capacity	Starting torque
Load type	Friction load and weight load Liquid (viscous) load Inertia load Load with power transmission	•			•
Load speed and torque characteristics	Constant torque Constant output Decreasing torque Decreasing output	•	•		
Load characteristics	Constant load Shock load Repetitive load High starting torque Low starting torque	•	•	•	•
Operation mode	Continuous operation Short-time operation Long-time operation at medium/low speeds		•	•	
Rated output	Maximum output current (instantaneous) Constant output current (continuous)	•		•	
Rated speed	Maximum frequency Base frequency	•			
Power supply	Power supply transformer capacity or percentage impedance Voltage fluctuations and unbalance Number of phases, single phase protection Frequency			•	•
Load capacity change	Mechanical friction, losses in wiring			•	•
	Duty cycle modification		•		

C.1 Capacity Formulas

1. One AC motor drive operates one motor

The starting capacity should be less than 1.5x the rated capacity of the AC motor drive.
The starting capacity equals:

$$\frac{k \times N}{973 \times \eta \times \cos \varphi} \left(T_L + \frac{GD^2}{375} \times \frac{N}{t_A} \right) \leq 1.5 \times \text{the_capacity_of_AC_motor_drive(kVA)}$$

2. One AC motor drive operates more than one motor

2.1 The starting capacity should be less than the rated capacity of the AC motor drive.

- Acceleration time ≤ 60 seconds

The starting capacity equals:

$$\frac{k \times N}{\eta \times \cos \varphi} \left[n_r + n_s(k_s - 1) \right] = P_{Cl} \left[1 + \frac{n_s}{n_r} (k_s - 1) \right] \leq 1.5 \times \text{the_capacity_of_AC_motor_drive(kVA)}$$

- Acceleration time ≥ 60 seconds

The starting capacity equals:

$$\frac{k \times N}{\eta \times \cos \varphi} \left[n_r + n_s(k_s - 1) \right] = P_{Cl} \left[1 + \frac{n_s}{n_r} (k_s - 1) \right] \leq \text{the_capacity_of_AC_motor_drive(kVA)}$$

2.2 The current should be less than the rated current of the AC motor drive (A).

- Acceleration time ≤ 60 seconds

$$n_r + I_M \left[1 + \frac{n_s}{n_r} (k_s - 1) \right] \leq 1.5 \times \text{the_rated_current_of_AC_motor_drive(A)}$$

- Acceleration time ≥ 60 seconds

$$n_r + I_M \left[1 + \frac{n_s}{n_r} (k_s - 1) \right] \leq \text{the_rated_current_of_AC_motor_drive(A)}$$

2.3 When running continuously

- The load capacity requirement should be less than the capacity of the AC motor drive (kVA).
The load capacity requirement equals:

$$\frac{k \times P_M}{\eta \times \cos \varphi} \leq \text{the_capacity_of_AC_motor_drive(kVA)}$$

- The motor capacity should be less than the capacity of the AC motor drive.

$$k \times \sqrt{3} \times V_M \times I_M \times 10^{-3} \leq \text{the_capacity_of_AC_motor_drive(kVA)}$$

- The current should be less than the rated current of the AC motor drive (A).

$$k \times I_M \leq \text{the_rated_current_of_AC_motor_drive(A)}$$

Symbol explanation

P_M	Motor shaft output for load (kW)
η	Motor efficiency (normally approx. 0.85)
$\cos \varphi$	Motor power factor (normally approx. 0.75)
V_M	Motor rated voltage (V)
I_M	Motor rated current (A), for commercial power
k	Correction factor calculated from the current distortion factor (1.05–1.1, depending on PWM method)
P_{C1}	Continuous motor capacity (kVA)
k_s	Starting current/rated current of the motor
n_T	Number of motors in parallel
n_s	Number of simultaneously started motors
GD^2	Total inertia (GD^2) calculated back to motor shaft (kg m^2)
T_L	Load torque
t_A	Motor acceleration time
N	Motor speed

C.2 General Precautions

Selecting an AC Motor Drive

- ☑ When connecting the AC motor drive directly to a large-capacity power transformer (600 kVA or higher), or when switching a phase lead capacitor, excess peak currents may occur in the power input circuit and may damage the converter section. To avoid this, use an AC input reactor (optional) before the AC motor drive mains input to reduce the current and improve the input power efficiency.
- ☑ When using a special motor or when driving more than one motor in parallel with a single AC motor drive, select the AC motor drive current to be $\geq 1.25x$ (sum of the motor rated currents).
- ☑ The starting acceleration and deceleration characteristics of a motor are limited by the AC motor drive rated current and the overload protection. Compared to running the motor D.O.L. (Direct On-Line), you can expect a lower starting torque output with the AC motor drive. If a higher starting torque is required (such as for elevators, mixers, tooling machines, etc.), use a higher capacity AC motor drive or increase the capacities of both the motor and the AC motor drive.
- ☑ When a fault occurs on the drive, a protective circuit is activated and the AC motor drive output is turned off. The motor coasts to stop. For an emergency stop, use an external mechanical brake to quickly stop the motor.

Setting Parameters

- ☑ You can set the AC motor drive to an output frequency up to 400 Hz (less for some models) with the digital keypad. Setting errors may create a dangerous situation. For safety, setting an upper limit frequency function is strongly recommended.
- ☑ High DC brake operating voltages and long operation time (at low frequencies) may cause overheating of the motor. In that case, forced external motor cooling is recommended.
- ☑ Motor acceleration and deceleration time is determined by motor rated torque, load torque, and load inertia.
- ☑ If you activate the stall prevention function, the acceleration and deceleration time is automatically extended to a length that the AC motor drive can handle. If the motor must decelerate within a certain time with a higher load inertia than the AC motor drive can handle in the required time, either use an external brake resistor and/or a brake unit (depending on the model) to shorten deceleration time only, or increase the capacity of both the motor and the AC motor drive.

C.3 How to Choose a Suitable Motor

Standard Motors

When using the AC motor drive to operate a standard three-phase induction motor, follow these precautions.

- The energy loss is greater than that for an inverter-duty motor.
- Avoid running the motor at low speed for a long time. Under this condition, the motor temperature may rise above the motor rating due to limited airflow produced by the motor's fan. Consider adding external forced motor cooling.
- When the standard motor operates at low speed for a long time, the output load must be decreased.
- The load tolerance of a standard motor is according to the following diagram.

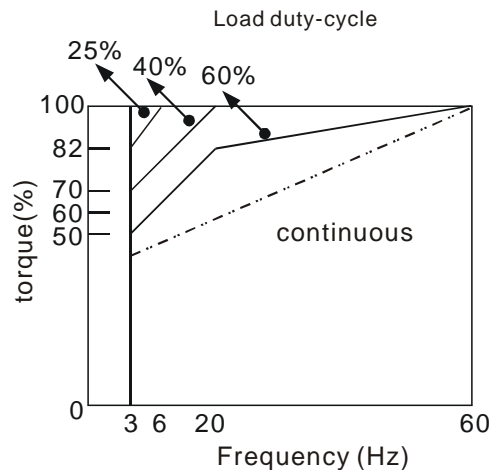

- If 100% of continuous torque is required at low speed, it may be necessary to use a special inverter-duty motor.
- Motor dynamic balance and rotor endurance should be considered once the operating speed exceeds the rated speed (60Hz) for a standard motor.
- Motor torque characteristics vary when driving the motor with an AC motor drive instead of a commercial power supply. Check the load torque characteristics of the machine connected to the motor.
- Because of the high carrier frequency PWM control of the VFD series, pay attention to the following motor vibration problems:
 - Resonant mechanical vibration: use anti-vibration dampers to mount equipment that runs at varying speed.
 - Motor imbalance: special care is required for operation at 60 Hz and higher frequencies.
- The motor fan is very noisy when the motor speed exceeds 60 Hz or above.

Special Motors

- Pole-changing (Dahlander) motor:

The rated current differs from that of a standard motor. Check before operation and carefully choose the capacity of the AC motor drive. When changing the number of poles, stop the motor first. If over-current occurs during operation or the regenerative voltage is too high, let the motor free run to stop (coast).
- Submersible motor:

The rated current is higher than that of a standard motor. Check before operation and carefully choose the capacity of the AC motor drive. A long motor cable between the AC motor drive and the motor reduces the available motor torque.
- Explosion-proof (Ex) motor:

Must be installed in a safe place and the wiring should comply with the (Ex) requirements. Delta AC Motor Drives are not suitable for (Ex) areas that require special precautions.
- Gear reduction motor:

The lubricating method of the reduction gearbox and the speed range for continuous operation are different and depend on the motor brand. Carefully consider the lubricating method when operating for a long time at low speed and for high-speed operation.
- Synchronous motor:

The rated current and the starting current are higher than those of standard motors. Check before

operation and carefully choose the capacity of the AC motor drive. When one AC motor drive operates more than one motors, pay attention to starting and changing the motor.

Power Transmission Mechanism

Pay attention to reduced lubrication when operating equipment such as gear reduction motors, gearboxes, belts and chains over long periods at low speeds. At high speeds (60 Hz and above), noises and vibrations that reduce the lifetime of the equipment may occur.

Motor Torque

The motor torque characteristics operated by an AC motor drive depend on the motor model selection and AC motor drive parameter settings.

This page intentionally left blank.